



Areamaster™ Generation 2 and High Lumen LED Luminaire

Floodlight for Hazardous Locations

NEC/CEC:

Class I, Division 2, Groups A, B, C, D Class I,
Zone 2 AEx/Ex ec Group IIC Gc Class II,
Division 1 and 2, Groups E, F, G Class III
Zone 20 and 21 Group IIIC

NEC/CEC:

Zone 21, AEx/Ex tb Group IIIC Db
Simultaneous Exposure
Marine Outside Type (Salt Water) for USA ONLY
Wet Locations
Type 3R, 4, 4X, IP66/67

ATEX/IECEX:

Zone 2 and 21
IP66
II 3G 2D
IK10
Ex ec IIC T5

Applications

- Enclosed and gasketed fixtures suitable for use in a wide range of industrial, chemical processing and other areas where flammable gases and vapors are present, for example:
 - Oil and Gas Refineries
 - Petrochemical Plants
 - Foundries
 - Drilling Rigs
 - Pulp and Paper Mills
 - Food and Beverage Processing Facilities
 - Loading Docks
 - Power Plants
 - Water and Wastewater Treatment Facilities
 - Other areas where corrosive, wet, dirty and tough environments are a problem
- IP66/IP67, Type 4X, marine and wet locations. IP66 for IECEX/ATEX.
- Locations requiring dependable, consistent lighting in extreme hot/cold temperature environments. -40°C to +65°C (-40°F to +149°F) ambient temperature range. -40°C to +55°C (-40°F to +131°F) for high lumen AMLHL3 output.
- Globally rated luminaires with all applicable certification labels for NEC/CEC and ATEX/IECEX environments. See Certifications and Compliances for details.

Features

- Six lumen outputs provide up to 38,000 lumens.

Nominal Lumens ①	Wattage (W)	Efficacy (lpw)	HID Equivalent	Model Number
9,500	70	136	175W-250W	AMLGL6
15,000	111	135	250W-400W	AMLGL7
19,500	152	125	400W-750W	AMLGL8
24,000	177	136	1000W	AMLHL1
30,000	221	136	1000-1500W	AMLHL2
38,000	297	128	1500W	AMLHL3

① Nominal lumen value for 5000K, NEMA 7x7, with clear glass. Detailed lumen information provided in tables.

- Choice of optics for optimal light distribution in a variety of applications.
- Separate field wiring compartment with screw terminal block for easy and secure connection (can accept UL/CSA 26-10AWG).
- Two 3/4" NPT entries provided. Optional M20 metric adapters available.
- Yoke bracket is designed to accommodate traditional Areamaster brackets and slipfitters for easy retrofit. Optional stainless steel yoke bracket is available.
- Choice of color temperature (CCT): 5000K cool white, 4000K neutral white, or 3000K warm white.
- Rugged and compact housing with superior thermal design translates to long luminaire life.
- Heavy duty, high temperature silicone rubber gaskets.
- Thermal shock and impact resistant clear or frosted glass lens.
- Standard 6KV surge protection.
- Captive fasteners secure one piece lens.
- Field replaceable LED driver and lens cover.



AMLG

Options

- Improved safety cable design with multiple retention points, purchase separately
- Guard and visor available, purchase separately
- Slip-fitters and mounting brackets available for easy pole or wall mounting
- Stainless steel yoke bracket
- 10kV Surge Protection, for NEC/CEC only

Standard Materials

- Housing and lens door: copperfree (4/10 of 1% max.) aluminum
- Gaskets: silicone rubber
- Yoke: zinc plated HR steel
- Bolts: stainless steel
- Close up plugs: (1) aluminum provided
- Guard and safety cable: stainless steel
- Visor: Aluminum

Standard Finishes

- Housing, lens cover, visor and yoke mount: architectural bronze polyester

Related Products

- Industrial Areamaster Generation 2 and High Lumen LED
- Round Tapered Steel Poles
- Hinged Steel Poled
- Square Tapered Steel Poles
- Square Steel Poles
- Floodlight Mounting Brackets

APPLETON™

LED/FLOODLIGHTS: NEC/CEC, ATEX/IECEX ENCLOSED AND GASKETED



Areamaster™ Generation 2 and High Lumen LED Luminaire Floodlight for Hazardous Locations

NEC/CEC:

Class I, Division 2, Groups A, B, C, D
Class I, Zone 2 AEx/Ex ec Group IIC Gc
Class II, Division 1 and 2, Groups E, F, G
Class III
Zone 20 and 21 Group IIIC

NEC/CEC:

Zone 21, AEx/Ex tb Group IIIC Db
Simultaneous Exposure
Marine Outside Type (Salt Water) for USA ONLY
Wet Locations
Type 3R, 4, 4X, IP66/67

ATEX/IECEX:

Zone 2 and 21
IP66
II 3G 2D
IK10
Ex ec IIC T5

NEC/CEC Certifications and Compliances

- UL Standards:
 - UL844, Luminaires for Use in Hazardous Locations
 - UL1598, Luminaires
 - UL1598A, Luminaires for Installation on Marine Vessels
 - UL 8750, LED Equipment for Use in Lighting Products
- CSA Standards:
 - CSA C22.2 No. 250.0, Luminaires
 - CSA C22.2 No. 137, Luminaires for Use in Hazardous Locations
- cCSAus 164460 Certificate Number: AMLG – 70073611, AMLH – 70073613



AMLH

ATEX/IECEX Certifications and Compliances

- Certification Type: Areamaster Generation 2 and High Lumen LED
 - Gas: Zone 2
 - Type of Protection: Ex ec IIC Gc
 - Temperature Class: AMLG – T5 to T3; AMLH – T4 to T3
 - Dust: Zone 21
 - Type of Protection: Ex op is tb IIIC Db
 - Surface Temperature: +85°C to +100°C (+185°F to +212°F)
- Ambient Temperature: -40°C up to +65°C (-40°F up to +149 °F). -40°C to +55°C (-40°F to +131°F) for high lumen AMLHL3 output.
- ATEX Certificate: ITS18ATEX104171 Issue 01
- IECEX Certificate: IECEX ITS 18.0049_1
- Index of Protection according EN/IEC 60529: IP66
- Impact Resistance (shock): IK10
- Photobiological Safety, IEC 62778 and IEC 62471: Risk Group 1 (RG1)

DesignLights™ Consortium (for the following models)

- All models pending.

APPLETON™

LED/FLOODLIGHTS: NEC/CEC, ATEX/IECEX ENCLOSED AND GASKETED

Areamaster™ Generation 2 and High Lumen LED Luminaire Floodlight for Hazardous Locations

NEC/CEC:

Class I, Division 2, Groups A, B, C, D
Class I, Zone 2 AEx/Ex ec Group IIC Gc
Class II, Division 1 and 2, Groups E, F, G
Class III
Zone 20 and 21 Group IIIC

NEC/CEC:

Zone 21, AEx/Ex tb Group IIIC Db
Simultaneous Exposure
Marine Outside Type (Salt Water) for USA ONLY
Wet Locations
Type 3R, 4, 4X, IP66/67

ATEX/IECEX:

Zone 2 and 21
IP66
II 3G 2D
IK10
Ex ec IIC T5

Illustrated Features

Light Where You Need It

Choose from 3 color temperatures and a variety of secondary optics to put light where your application needs it most. Unsure of which optic is best for your job? Contact your sales representative to get a free 3D Dialux simulation.

The Right Beam Pattern for Your Application

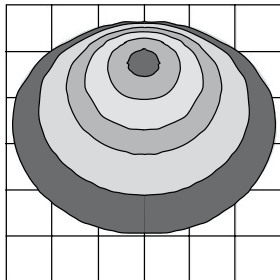

NEMA 7x7 – Uniform light spread, perfect for most typical flood lighting applications.

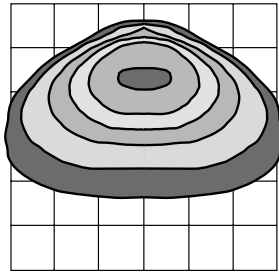

NEMA 7x6 – Mimics traditional HID light distribution. Light intensity is directed forward and side-to-side to maximize spacing between luminaires.

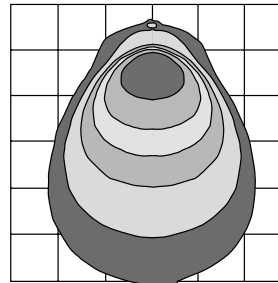

NEMA 5x5 – Narrow, spot type forward intensity focus. Enables higher mounting heights (50 ft / 15m+) while maintaining delivered light on surface (footcandles/lux).

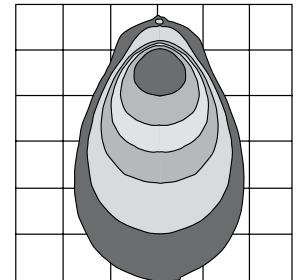

NEMA 3x3 – Very Narrow, spot type forward intensity focus. Enables highest mounting heights (100 ft / 30m+) while maintaining delivered light on surface (footcandles/lux).



Front-Facing Wiring Compartment

The Areamaster gasketed front wiring compartment with screw terminal block, and captive screws offers unmatched installation ease and convenience.



Replaceable Drivers

Easy to access, field replaceable drivers extend the useful life of your luminaire up to 200,000 hours or more. Shown above, the Areamaster High Lumen which demands two LED drivers for the very bright outputs up to 38,000 lumens.



Visor and Guard

Whether using to comply with light pollution regulations, or simply controlling your light more and protection your lens, our optional visor and guards are readily available for your applications.

APPLETON™

LED/FLOODLIGHTS: NEC/CEC, ATEX/IECEX ENCLOSED AND GASKETED



Areamaster™ Generation 2 and High Lumen LED Luminaire Floodlight for Hazardous Locations

NEC/CEC:

Class I, Division 2, Groups A, B, C, D
Class I, Zone 2 AEx/Ex ec Group IIC Gc
Class II, Division 1 and 2, Groups E, F, G
Class III
Zone 20 and 21 Group IIIC

NEC/CEC:

Zone 21, AEx/Ex tb Group IIIC Db
Simultaneous Exposure
Marine Outside Type (Salt Water) for USA ONLY
Wet Locations
Type 3R, 4, 4X, IP66/67

ATEX/IECEX:

Zone 2 and 21
IP66
II 3G 2D
IK10
Ex ec IIC T5

Order using catalog numbering guides below or select catalog number from tables on following pages.

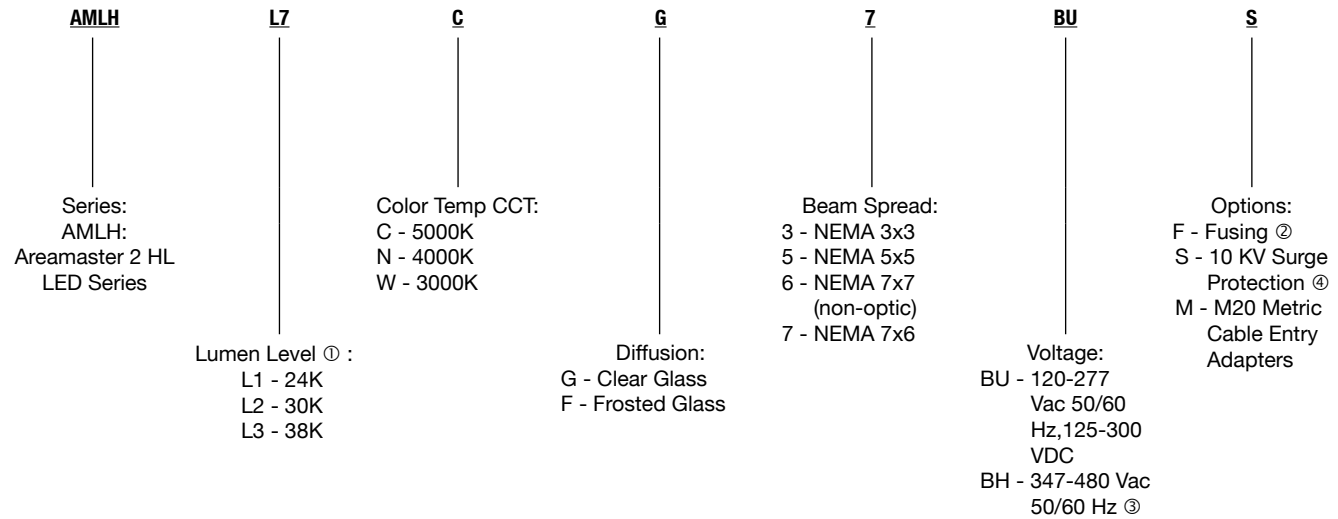
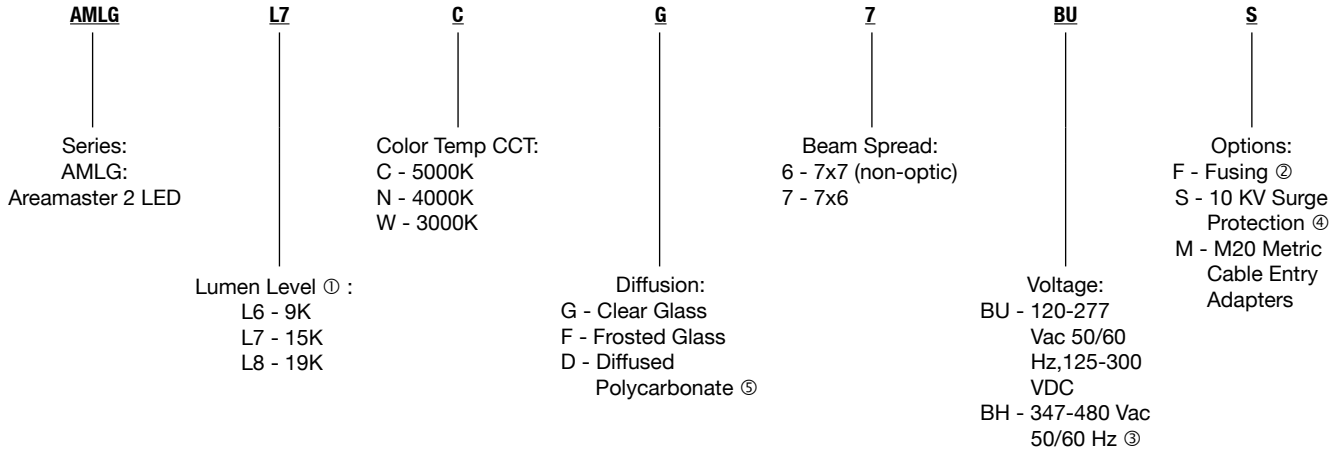

① All lumen values are typical (tolerance +/- 10%)
② Use of fuse voids Marine rating. Fusing available for NEC/CEC only.
③ BH voltage available for NEC/CEC only.
④ 10kV Surge Protection available for NEC/CEC only.
⑤ Diffused polycarbonate available for NEC/CEC only.

Areamaster™ Generation 2 and High Lumen LED Luminaire Floodlight for Hazardous Locations

NEC/CEC:

Class I, Division 2, Groups A, B, C, D
Class I, Zone 2 AEx/Ex ec Group IIC Gc
Class II, Division 1 and 2, Groups E, F, G
Class III
Zone 20 and 21 Group IIIC



NEC/CEC:

Zone 21, AEx/Ex tb Group IIIC Db
Simultaneous Exposure
Marine Outside Type (Salt Water) for USA ONLY
Wet Locations
Type 3R, 4, 4X, IP66/67

ATEX/IECEX:

Zone 2 and 21
IP66
II 3G 2D
IK10
Ex ec IIC T5

Lumen Output Tables – AML

Diffusion	Color Temperature CCT	Lumen Output ①	Wattage	Efficacy (lm/W)	Optical Pattern	Catalog Number ②	
	5000K Cool White	9,900	70	141	NEMA 7x7	AMLGL6CG6BU	
		9,500		136	NEMA 7x6	AMLGL6CG7BU	
		15,000	111	135	NEMA 7x7	AMLGL7CG6BU	
		14,500		131	NEMA 7x6	AMLGL7CG7BU	
		19,500	152	128	NEMA 7x7	AMLGL8CG6BU	
		18,500		122	NEMA 7x6	AMLGL8CG7BU	
	4000K Neutral White	9,000	70	129	NEMA 7x7	AMLGL6NG6BU	
		8,500		121	NEMA 7x6	AMLGL6NG7BU	
		13,650	111	123	NEMA 7x7	AMLGL7NG6BU	
		12,950		117	NEMA 7x6	AMLGL7NG7BU	
		17,550	152	115	NEMA 7x7	AMLGL8NG6BU	
		16,550		109	NEMA 7x6	AMLGL8NG7BU	
		3000K Warm White	7,650	70	109	NEMA 7x7	AMLGL6WG6BU
			7,350		105	NEMA 7x6	AMLGL6WG7BU
11,500			111	104	NEMA 7x7	AMLGL7WG6BU	
11,000				99	NEMA 7x6	AMLGL7WG7BU	
15,000			152	99	NEMA 7x7	AMLGL8WG6BU	
14,500		95		NEMA 7x6	AMLGL8WG7BU		
5000K Cool White		8,300	70	119	NEMA 7x7	AMLGL6CF6BU	
		7,900		113	NEMA 7x6	AMLGL6CF7BU	
		12,500	111	113	NEMA 7x7	AMLGL7CF6BU	
		12,000		108	NEMA 7x6	AMLGL7CF7BU	
	16,550	152	109	NEMA 7x7	AMLGL8CF6BU		
15,550	102		NEMA 7x6	AMLGL8CF7BU			
4000K Neutral White	7,500	70	107	NEMA 7x7	AMLGL6NF6BU		
	7,200		103	NEMA 7x6	AMLGL6NF7BU		
	11,350	111	102	NEMA 7x7	AMLGL7NF6BU		
	10,950		99	NEMA 7x6	AMLGL7NF7BU		
	14,500	152	95	NEMA 7x7	AMLGL8NF6BU		
14,000	92		NEMA 7x6	AMLGL8NF7BU			
3000K Warm White	6,400	70	91	NEMA 7x7	AMLGL6WF6BU		
	6,200		89	NEMA 7x6	AMLGL6WF7BU		
	9,700	111	87	NEMA 7x7	AMLGL7WF6BU		
	9,400		85	NEMA 7x6	AMLGL7WF7BU		
	12,500	152	82	NEMA 7x7	AMLGL8WF6BU		
12,000	79		NEMA 7x6	AMLGL8WF7BU			

① All lumen values and wattage typical (tolerance +/- 10%)

② For 347-480 Vac voltage, change **-BU** suffix to **-BH**, example AMLGL1CG6BH.

For 3/4" NPT to M20 metric adapters, add suffix **-M** to end of part number, example AMLGL1CG6BUM.

For Fusing option, add suffix **-F** to end of part number, example AMLGL1CG6BUF.

For 10KV surge protection, add suffix **-S** to end of part number, example AMLGL1CG7BUS.

For both Fusing and 10KV surge, add suffix **-FS** to end of part number, example AMLGL1CG7BUFS.

See catalog numbering guide for certification restrictions.



Areamaster™ Generation 2 and High Lumen LED Luminaire Floodlight for Hazardous Locations

NEC/CEC:

Class I, Division 2, Groups A, B, C, D
Class I, Zone 2 AEx/Ex ec Group IIC Gc
Class II, Division 1 and 2, Groups E, F, G
Class III
Zone 20 and 21 Group IIIC

NEC/CEC:

Zone 21, AEx/Ex tb Group IIIC Db
Simultaneous Exposure
Marine Outside Type (Salt Water) for USA ONLY
Wet Locations
Type 3R, 4, 4X, IP66/67

ATEX/IECEX:

Zone 2 and 21
IP66
II 3G 2D
IK10
Ex ec IIC T5

Lumen Output Tables — AML

Diffusion	Color Temperature CCT	Lumen Output ①	Wattage	Efficacy (lm/W)	Optical Pattern	Catalog Number ②	
	5000K Cool White	8,050	70	115	NEMA 7x7	AMLGL6CD6BU	
		7,700		110	NEMA 7x6	AMLGL6CD7BU	
		12,200	111	110	NEMA 7x7	AMLGL7CD6BU	
		11,700		105	NEMA 7x6	AMLGL7CD7BU	
		15,650	152	103	NEMA 7x7	AMLGL8CD6BU	
		15,000		99	NEMA 7x6	AMLGL8CD7BU	
	Diffused Polycarbonate	4000K Neutral White	7,300	70	104	NEMA 7x7	AMLGL6ND6BU
			6,950		99	NEMA 7x6	AMLGL6ND7BU
			11,000	111	99	NEMA 7x7	AMLGL7ND6BU
		10,550	95		NEMA 7x6	AMLGL7ND7BU	
		14,150	152	93	NEMA 7x7	AMLGL8ND6BU	
		13,500		89	NEMA 7x6	AMLGL8ND7BU	
	3000K Warm White	6,250	70	89	NEMA 7x7	AMLGL6WD6BU	
				85	NEMA 7x6	AMLGL6WD7BU	
9,450		111	85	NEMA 7x7	AMLGL7WD6BU		
9,000			81	NEMA 7x6	AMLGL7WD7BU		
12,100		152	80	NEMA 7x7	AMLGL8WD6BU		
11,500	76		NEMA 7x6	AMLGL8WD7BU			

① All lumen values and wattage typical (tolerance +/- 10%)

② For 347-480 Vac voltage, change **-BU** suffix to **-BH**, example AMLGL1CG6BH.

For 3/4" NPT to M20 metric adapters, add suffix **-M** to end of part number, example AMLGL1CG6BUM.

For Fusing option, add suffix **-F** to end of part number, example AMLGL1CG6BUF.

For 10KV surge protection, add suffix **-S** to end of part number, example AMLGL1CG7BUS.

For both Fusing and 10KV surge, add suffix **-FS** to end of part number, example AMLGL1CG7BUFS.

See catalog numbering guide for certification restrictions.

Areamaster™ Generation 2 and High Lumen LED Luminaire Floodlight for Hazardous Locations

NEC/CEC:

Class I, Division 2, Groups A, B, C, D
Class I, Zone 2 AEx/Ex ec Group IIC Gc
Class II, Division 1 and 2, Groups E, F, G
Class III
Zone 20 and 21 Group IIIC

NEC/CEC:

Zone 21, AEx/Ex tb Group IIIC Db
Simultaneous Exposure
Marine Outside Type (Salt Water) for USA ONLY
Wet Locations
Type 3R, 4, 4X, IP66/67

ATEX/IECEX:

Zone 2 and 21
IP66
II 3G 2D
IK10
Ex ec IIC T5

Lumen Output Tables — AMLH

Diffusion	Color Temperature CCT	Lumen Output ①	Wattage	Efficacy (lm/W)	Optical Pattern	Catalog Number ②	
Clear Glass	5000K Cool White	24,250	178	136	NEMA 7x7	AMLHL1CG6BU	
		23,000		129	NEMA 7x6	AMLHL1CG7BU	
		25,000		140	NEMA 5x5	AMLHL1CG5BU	
		22,750	222	128	NEMA 3x3	AMLHL1CG3BU	
		29,750		134	NEMA 7x7	AMLHL2CG6BU	
		27,950		126	NEMA 7x6	AMLHL2CG7BU	
		30,000		135	NEMA 5x5	AMLHL2CG5BU	
		27,500		124	NEMA 3x3	AMLHL2CG3BU	
		37,400		126	NEMA 7x7	AMLHL3CG6BU	
	35,350	298	119	NEMA 7x6	AMLHL3CG7BU		
	37,500		126	NEMA 5x5	AMLHL3CG5BU		
	34,750	117	NEMA 3x3	AMLHL3CG3BU			
	Clear Glass	4000K Neutral White	21,300	178	120	NEMA 7x7	AMLHL1NG6BU
			20,500		115	NEMA 7x6	AMLHL1NG7BU
			21,900		123	NEMA 5x5	AMLHL1NG5BU
			20,250	222	114	NEMA 3x3	AMLHL1NG3BU
			26,100		118	NEMA 7x7	AMLHL2NG6BU
			25,000		113	NEMA 7x6	AMLHL2NG7BU
26,700			120		NEMA 5x5	AMLHL2NG5BU	
24,600			111		NEMA 3x3	AMLHL2NG3BU	
32,800			110		NEMA 7x7	AMLHL3NG6BU	
31,500		298	106	NEMA 7x6	AMLHL3NG7BU		
33,600			113	NEMA 5x5	AMLHL3NG5BU		
30,950		104	NEMA 3x3	AMLHL3NG3BU			
3000K Warm White		20,100	178	113	NEMA 7x7	AMLHL1WG6BU	
		19,000		107	NEMA 7x6	AMLHL1WG7BU	
		20,850		117	NEMA 5x5	AMLHL1WG5BU	
		19,350	222	109	NEMA 3x3	AMLHL1WG3BU	
		24,650		111	NEMA 7x7	AMLHL2WG6BU	
		23,200		105	NEMA 7x6	AMLHL2WG7BU	
	25,500	115		NEMA 5x5	AMLHL2WG5BU		
	23,450	106		NEMA 3x3	AMLHL2WG3BU		
	31,000	104		NEMA 7x7	AMLHL3WG6BU		
29,300	298	98	NEMA 7x6	AMLHL3WG7BU			
32,000		107	NEMA 5x5	AMLHL3WG5BU			
29,500	99	NEMA 3x3	AMLHL3WG3BU				



① All lumen values and wattage typical (tolerance +/- 10%)

② For 347-480 Vac voltage, change **-BU** suffix to **-BH**, example AMLHL1CG6BH.

For 3/4" NPT to M20 metric adapters, add suffix **-M** to end of part number, example AMLHL1CG6BUM.

For Fusing option, add suffix **-F** to end of part number, example AMLHL1CG6BUF.

For 10KV surge protection, add suffix **-S** to end of part number, example AMLHL1CG7BUS.

For both Fusing and 10KV surge, add suffix **-FS** to end of part number, example AMLHL1CG7BUFS.

See catalog numbering guide for certification restrictions.

APPLETON™

LED/FLOODLIGHTS: NEC/CEC, ATEX/IECEX ENCLOSED AND GASKETED



Areamaster™ Generation 2 and High Lumen LED Luminaire Floodlight for Hazardous Locations

NEC/CEC:

Class I, Division 2, Groups A, B, C, D
Class I, Zone 2 AEx/Ex ec Group IIC Gc
Class II, Division 1 and 2, Groups E, F, G
Class III
Zone 20 and 21 Group IIIC

NEC/CEC:

Zone 21, AEx/Ex tb Group IIIC Db
Simultaneous Exposure
Marine Outside Type (Salt Water) for USA ONLY
Wet Locations
Type 3R, 4, 4X, IP66/67

ATEX/IECEX:

Zone 2 and 21
IP66
II 3G 2D
IK10
Ex ec IIC T5

Lumen Output Tables — AMLH

Diffusion	Color Temperature CCT	Lumen Output ①	Wattage	Efficacy (lm/W)	Optical Pattern	Catalog Number ②		
Frosted Glass	5000K Cool White	20,500	178	115	NEMA 7x7	AMLHL1CF6BU		
		19,500		110	NEMA 7x6	AMLHL1CF7BU		
		21,550		121	NEMA 5x5	AMLHL1CF5BU		
		20,000	222	112	NEMA 3x3	AMLHL1CF3BU		
		25,000		113	NEMA 7x7	AMLHL2CF6BU		
		23,700		107	NEMA 7x6	AMLHL2CF7BU		
		26,000		117	NEMA 5x5	AMLHL2CF5BU		
		24,750		111	NEMA 3x3	AMLHL2CF3BU		
		31,500		106	NEMA 7x7	AMLHL3CF6BU		
		29,950	298	101	NEMA 7x6	AMLHL3CF7BU		
		33,500		112	NEMA 5x5	AMLHL3CF5BU		
		31,000		104	NEMA 3x3	AMLHL3CF3BU		
		Frosted Glass	4000K Neutral White	18,000	178	101	NEMA 7x7	AMLHL1NF6BU
				17,300		97	NEMA 7x6	AMLHL1NF7BU
				19,350		109	NEMA 5x5	AMLHL1NF5BU
				17,950	222	101	NEMA 3x3	AMLHL1NF3BU
21,950	99			NEMA 7x7		AMLHL2NF6BU		
21,000	95			NEMA 7x6		AMLHL2NF7BU		
23,600	106			NEMA 5x5		AMLHL2NF5BU		
21,950	99			NEMA 3x3		AMLHL2NF3BU		
27,700	93			NEMA 7x7		AMLHL3NF6BU		
26,550	298			89	NEMA 7x6	AMLHL3NF7BU		
29,750				100	NEMA 5x5	AMLHL3NF5BU		
27,500				92	NEMA 3x3	AMLHL3NF3BU		
Frosted Glass	3000K Warm White			16,850	178	95	NEMA 7x7	AMLHL1WF6BU
				16,150		91	NEMA 7x6	AMLHL1WF7BU
				18,600		104	NEMA 5x5	AMLHL1WF5BU
				17,200	222	97	NEMA 3x3	AMLHL1WF3BU
		20,550	93	NEMA 7x7		AMLHL2WF6BU		
		19,600	88	NEMA 7x6		AMLHL2WF7BU		
		22,650	102	NEMA 5x5		AMLHL2WF5BU		
		21,000	95	NEMA 3x3		AMLHL2WF3BU		
		26,000	87	NEMA 7x7		AMLHL3WF6BU		
		24,750	298	83	NEMA 7x6	AMLHL3WF7BU		
		28,600		96	NEMA 5x5	AMLHL3WF5BU		
		26,400		89	NEMA 3x3	AMLHL3WF3BU		



Frosted Glass

① All lumen values and wattage typical (tolerance +/- 10%)

② For 347-480 Vac voltage, change **-BU** suffix to **-BH**, example AMLHL1CG6BH.

For 3/4" NPT to M20 metric adapters, add suffix **-M** to end of part number, example AMLHL1CG6BUM.

For Fusing option, add suffix **-F** to end of part number, example AMLHL1CG6BUF.

For 10KV surge protection, add suffix **-S** to end of part number, example AMLHL1CG7BUS.

For both Fusing and 10KV surge, add suffix **-FS** to end of part number, example AMLHL1CG7BUFS.

See catalog numbering guide for certification restrictions.

Areamaster™ Generation 2 and High Lumen LED Luminaire Floodlight for Hazardous Locations

NEC/CEC:

Class I, Division 2, Groups A, B, C, D
Class I, Zone 2 AEx/Ex ec Group IIC Gc
Class II, Division 1 and 2, Groups E, F, G
Class III
Zone 20 and 21 Group IIIC

NEC/CEC:

Zone 21, AEx/Ex tb Group IIIC Db
Simultaneous Exposure
Marine Outside Type (Salt Water) for USA ONLY
Wet Locations
Type 3R, 4, 4X, IP66/67

ATEX/IECEX:

Zone 2 and 21
IP66
II 3G 2D
IK10
Ex ec IIC T5

Electrical Ratings ①

Voltage Suffix	Voltage (V)	Input Power (Watts)	Input Current (Amps)	Power Factor (PF)	Total Harmonic Distortion (THD)	Model Number	
AMLG							
BU	120 Vac	73	0.62	>.9	<20%	AMLGL6	
	277 Vac	71	0.27				
	170 Vdc	69	0.41	N/A	N/A		
	300 Vdc	68	0.23				
BH	347 Vac	71	0.21	>.9	<20%		
	480 Vac	71	0.16				
BU	120 Vac	111	0.94	>.9	<20%		AMLGL7
	277 Vac	106	0.43				
	170 Vdc	113	0.67	N/A	N/A		
	300 Vdc	111	0.37				
BH	347 Vac	115	0.33	>.9	<20%		
	480 Vac	115	0.25				
BU	120 Vac	154	1.30	>.9	<20%	AMLGL8	
	277 Vac	146	0.56				
	170 Vdc	156	0.92	N/A	N/A		
	300 Vdc	152	0.51				
BH	347 Vac	150	0.43	>.9	<20%		
	480 Vac	149	0.32				
AMLH							
BU	120 Vac	180	1.52	>.9	<20%		AMLHL1
	277 Vac	176	0.67				
	170 Vdc	172	1.02	N/A	N/A		
	300 Vdc	170	0.57				
BH	347 Vac	179	0.52	>.9	<20%		
	480 Vac	179	0.39				
BU	120 Vac	231	1.94	>.9	<20%	AMLHL2	
	277 Vac	231	0.88				
	170 Vdc	220	1.30	N/A	N/A		
	300 Vdc	217	0.72				
BH	347 Vac	219	0.64	>.9	<20%		
	480 Vac	219	0.47				
BU	120 Vac	317	2.67	>.9	<20%		AMLHL3
	277 Vac	303	1.15				
	170 Vdc	305	1.80	N/A	N/A		
	300 Vdc	298	0.99				
BH	347 Vac	299	0.87	>.9	<20%		
	480 Vac	298	0.63				

Surge Protection: Integral 6KV surge protection. Option for up to 10KV surge protection. (cCSAus only).

① All ratings are typical.

APPLETON™

LED/FLOODLIGHTS: NEC/CEC, ATEX/IECEX ENCLOSED AND GASKETED



Areamaster™ Generation 2 and High Lumen LED Luminaire Floodlight for Hazardous Locations

NEC/CEC:

Class I, Division 2, Groups A, B, C, D
Class I, Zone 2 AEx/Ex ec Group IIC Gc
Class II, Division 1 and 2, Groups E, F, G
Class III
Zone 20 and 21 Group IIIC

NEC/CEC:

Zone 21, AEx/Ex tb Group IIIC Db
Simultaneous Exposure
Marine Outside Type (Salt Water) for USA ONLY
Wet Locations
Type 3R, 4, 4X, IP66/67

ATEX/IECEX:

Zone 2 and 21
IP66
II 3G 2D
IK10
Ex ec IIC T5

NEC/CEC Temperature Codes

Series Number	Max Driver Current (mA)	Max Ambient C° (F°)	Gas		Dust		Combined Class I, Division 2 & Class II, Division 1	Gas Ex ec IIC, Class I, Zone 2, AEx ec IIC	Dust Ex tb IIIC, Zone 21, AEx tb IIIC
			Class I, Division 2 Groups A, B, C and D	Class I Zone 2 Group IIC	Class II, Division 1, Groups E, F and G	Zone 20, Group IIIC			
AMLGL6	410	40 (104)	T5	T5	T6	T6	T4A	T5	T85 °C
		55 (131)	T4A	T4	T6	T6	T4A	T4	T85 °C
		65 (149)	T4A	T4	T6	T6	T4	T4	T85 °C
AMLGL7	680	40 (104)	T4	T4	T6	T6	T4	T4	T85 °C
		55 (131)	T3C	T3	T6	T6	T3C	T3	T85 °C
		65 (149)	T3C ^①	T3 ^①	T5 ^①	T5 ^①	T3C ^①	T3 ^②	T100 °C ^②
AMLGL8	930	40 (104)	T3C	T3	T6	T6	T3C	T3	T85 °C
		55 (131)	T3B ^①	T3 ^①	T5 ^①	T5 ^①	T3A ^①	T3 ^①	T100 °C ^②
		65 (149)	T3A ^①	T3 ^①	T5 ^①	T5 ^①	T3A ^①	T3 ^①	T100 °C ^②
AMLHL1	530	40 (104)	T4A	T4	T6/T5 ^③	T6/T5 ^③	T4A	T4	T85°C/ T100°C ^③
		55 (131)	T4A	T4	T6/T5 ^③	T6/T5 ^③	T4A	T4	T85°C/ T100°C ^③
		65 (149)	T4	T4	T5 ^③	T5 ^③	T4	T4	T100°C
AMLHL2	680	40 (104)	T4	T4	T6/T5 ^③	T6/T5 ^③	T4	T4	T85°C/ T100°C ^③
		55 (131)	T4	T4	T5 ^③	T5 ^③	T4	T4	T100°C
		65 (149)	T3C	T3	T5 ^③	T5 ^③	T4	T3	T100°C
AMLHL3	915	40 (104)	T3C	T3	T6/T5 ^③	T6/T5 ^③	T3C	T3	T85°C/ T100°C ^③
		55 (131)	T3C	T3	T5 ^③	T5 ^③	T3C	T3	T100°C
		65 (149)	—	—	—	—	—	—	—

ATEX/IECEX Temperature Codes

Model Number	Max Driver Current (mA)	Gas			Dust		
		T Rating			Surface Temperature		
		+40°C (+104°F)	+55°C (+131°F)	+65°C (+149°F)	+40°C (+104°F)	+55°C (+131°F)	+65°C (+149°F)
AMLGL6	410	T5	T4	T4	T85°C	T85°C	T85°C
AMLGL7	680	T4	T3	T3	T85°C	T85°C	T100°C
AMLGL8	930	T3	T3	T3	T85°C	T100°C	T100°C
AMLHL1	530	T4	T4	T3	T85°C ^④	T85°C ^④	T85°C ^④
AMLHL2	680	T4	T4	T3	T85°C ^④	T100°C	T100°C
AMLHL3	915	T4	T3	—	T100°C	T100°C	—

Supply Wire Temperature for all: 90°C, 194°F

① Diffused polycarbonate lens option is not certified for these ambient temperature and lumen output combinations. Diffused polycarbonate not available for AMLH high lumen series.

② Diffused polycarbonate lens is certified for NEC/CEC only. No face up orientation for installation.

③ T5 is maximum allowed temperature code, and T100°C is maximum allowed temperature, when model number includes 3x3 secondary optic

④ Areamaster High Lumen with 3x3 secondary optic surface temperature is T100°C for these ranges.

⑤ For input voltages of 125-169 VDC, an ambient temperature exceeding 55°C is not permitted.

Areamaster™ Generation 2 and High Lumen LED Luminaire Floodlight for Hazardous Locations

NEC/CEC:

Class I, Division 2, Groups A, B, C, D
Class I, Zone 2 AEx/Ex tb Group IIC Gc
Class II, Division 1 and 2, Groups E, F, G
Class III
Zone 20 and 21 Group IIIC

NEC/CEC:

Zone 21, AEx/Ex tb Group IIIC Db
Simultaneous Exposure
Marine Outside Type (Salt Water) for USA ONLY
Wet Locations
Type 3R, 4, 4X, IP66/67

ATEX/IECEX:

Zone 2 and 21
IP66
II 3G 2D
IK10
Ex ec IIC T5

“T” Numbers Represent the Maximum Internal Temperature ① or Maximum Surface Temperature ②

“T” #	NEC/CEC															
	T1	350	325	T2	T2A	T2B	T2C	T2D	T3	T3A	T3B	T3C	T4	T4A	T5	T6
Temp. Range °C (°F)	351-450 (664-842)	326-350 (619-662)	301-325 (574-617)	281-300 (538-572)	261-280 (502-536)	231-260 (448-500)	216-230 (421-446)	201-215 (394-419)	181-200 (358-392)	166-180 (331-356)	161-165 (322-329)	136-160 (277-320)	121-135 (250-275)	101-120 (214-248)	86-100 (187-212)	85 (185)
“T” #	ATEX/IECEX						T3	T4	T5	T6						
	T1	T2		T3		T4					T5	T6				
Temp. Range °C (°F)	301-450 (547-842)	201-300 (394-572)		136-200 (277-392)		101-135 (214-275)	86-100 (187-212)	85 (185)								

Luminaire Category	Image	Frontal Projected Area (FPA) ft²	Drag Coefficient (DC)	Effective Projected Area (EPA) = FPA*DC ft²
AMLG				
90° to Ground-Worst Case Mounting		1.52	1.20	1.82
45° to Ground-Standard Mounting		1.07	1.2	1.28
AMLH				
90° to Ground-Worst Case Mounting		2.04	1.20	2.45
45° to Ground-Standard Mounting		1.44	1.20	1.73

① T numbers represent the maximum internal temperature for Class I, Division 2 and Class I, Zone 2 locations designated by the NEC.
② T numbers represent the maximum surface temperature under a dust blanket for Class II, Division 1 and 2 as designated by the NEC.



Areamaster™ Generation 2 and High Lumen LED Luminaire Floodlight for Hazardous Locations

NEC/CEC:

Class I, Division 2, Groups A, B, C, D
Class I, Zone 2 AEx/Ex ec Group IIC Gc
Class II, Division 1 and 2, Groups E, F, G
Class III
Zone 20 and 21 Group IIIC





NEC/CEC:

Zone 21, AEx/Ex tb Group IIIC Db
Simultaneous Exposure
Marine Outside Type (Salt Water) for USA ONLY
Wet Locations
Type 3R, 4, 4X, IP66/67

ATEX/IECEX:

Zone 2 and 21
IP66
II 3G 2D
IK10
Ex ec IIC T5

Accessories and Replacement Parts

	Description	Catalog Number
Crossarm Mounting Bracket		
	Has 180° horizontal adjustment — degree marked. Facilitates mounting floodlight to crossarm or other flat surface, or to GAM8WB. Includes floodlight yoke bolts. Malleable iron, zinc plated, chromate sealed, architectural bronze polyester finish.	GAM8CA
Pipe or Wall Mount Bracket		
	Used with GAM8CA. Clamps to 1" to 2-1/2" pipe, vertical or horizontal, or mounts on flat surfaces. Includes U-bolt and crossarm bracket bolts. Malleable iron, zinc plated, chromate sealed, with architectural bronze polyester finish.	GAM8WB
	Crossarm Mounting Bracket (GAM8CA) used with Pipe or Wall Mount Bracket (GAM8WB).	
Poletop Slip-Fitter		
	Slip-fits 1" or 1-1/2" pipe size poletop tenons. Includes floodlight yoke bolts, 3 locking bolts, and cord grip. Body is malleable iron-zinc plated, chromate sealed, with cast aluminum cap. Assembly has architectural bronze polyester finish.	AMLEDSF1
Poletop Slip-Fitter		
	Slip-fits 2" or 2-1/2" poletop tenons. Includes floodlight yoke bolts, 3 locking bolts, and cord grip. Malleable iron, zinc plated, chromate sealed, with architectural bronze polyester finish.	GAM8SF

APPLETON™

LED/FLOODLIGHTS: NEC/CEC, ATEX/IECEX ENCLOSED AND GASKETED

Areamaster™ Generation 2 and High Lumen LED Luminaire Floodlight for Hazardous Locations

NEC/CEC:

Class I, Division 2, Groups A, B, C, D
Class I, Zone 2 AEx/Ex ec Group IIC Gc
Class II, Division 1 and 2, Groups E, F, G
Class III
Zone 20 and 21 Group IIIC







NEC/CEC:

Zone 21, AEx/Ex tb Group IIIC Db
Simultaneous Exposure
Marine Outside Type (Salt Water) for USA ONLY
Wet Locations
Type 3R, 4, 4X, IP66/67

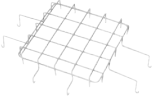
ATEX/IECEX:

Zone 2 and 21
IP66
II 3G 2D
IK10
Ex ec IIC T5

Accessories and Replacement Parts

	Description	Catalog Number
Wall Mount Bracket		
	Used with GAM8SF and GSF20 to provide a wall mounting option. Galvanized Steel.	GPSWB6GAL
Wire Guard		
	Stainless steel.	LGGUARD LHGUARD
Safety Cable		
	Stainless steel.	LEDSC
Visor		
	Steel with architectural bronze polyester finish. For Dark Sky Friendly design.	AMLGV AMLHV
Portable Floodlight Base		
	Portable floodlight base for temporary lighting applications. To be used with wire guard. Malleable iron with architectural bronze polyester finish.	GAMPFB
Replacement Covers		
		AMLGDIFFP AMLHCLEAR AMLHFROST
Yoke Mount Bracket		
	Stainless Steel Yoke Mount Bracket. For installations requiring a higher degree of corrosion protection. Made with all stainless steel components, no painted finish.	AMLYMSS
	Architectural Bronze Replacement Yoke Bracket	AMLYMAB

APPLETON™

LED/FLOODLIGHTS: NEC/CEC, ATEX/IECEX ENCLOSED AND GASKETED



Areamaster™ Generation 2 and High Lumen LED Luminaire Floodlight for Hazardous Locations

NEC/CEC:

Class I, Division 2, Groups A, B, C, D
Class I, Zone 2 AEx/Ex ec Group IIC Gc
Class II, Division 1 and 2, Groups E, F, G
Class III
Zone 20 and 21 Group IIIC



NEC/CEC:

Zone 21, AEx/Ex tb Group IIIC Db
Simultaneous Exposure
Marine Outside Type (Salt Water) for USA ONLY
Wet Locations
Type 3R, 4, 4X, IP66/67

ATEX/IECEX:

Zone 2 and 21
IP66
II 3G 2D
IK10
Ex ec IIC T5

Replacement Drivers

	Voltage	Driver Wattage	Constant Current Setting	Luminaire Model	CCT	Catalog Number
	BU	100 watt	410mA	AMLGL6C, AMLGL6W	5K and 3K	APMS100C105UD41
	BH					APMS100C105HD41
	BU	150 watt	650mA	AMLGL7W	3K	APMS150C105UD65
	BH					APMS150C105HD65
	BU	150 watt	680mA	AMLGL7C	5k	APMS150C105UD68
	BH					APMS150C105HD68
	BU	150 watt	890mA	AMLGL8W	3K	APMS150C105UD89
	BH					APMS150C105HD89
	BU	150 watt	930mA	AMLGL8C	5k	APMS150C105UD93
	BH					APMS150C105HD93

Areamaster Generation 2 Accessory Weights

Description	Weight in kg (lbs)
AMLGL6, AMLGL7, AMLGL8 Luminaires	9.8 (21.6)
AMLHL1, AMLHL2, AMLHL3 Luminaires	16.1 (35.4)
Yoke Bracket	1.41 (3.1)
Visor	0.2 (0.4)
Guard	0.2 (0.4)
Safety Cable	0.2 (0.4)
Crossarm Mounting Bracket GAM8CA	1.4 (3.1)
Pipe or Wall Mount Bracket GAM8WB	2.9 (6.4)
Poletop SlipFitter AMLEDSF1	2.4 (5.3)
Poletop SlipFitter GAM8SF	—

APPLETON™

LED/FLOODLIGHTS: NEC/CEC, ATEX/IECEX ENCLOSED AND GASKETED

Areamaster™ Generation 2 and High Lumen LED Luminaire Floodlight for Hazardous Locations

NEC/CEC:

Class I, Division 2, Groups A, B, C, D
Class I, Zone 2 AEx/Ex ec Group IIC Gc
Class II, Division 1 and 2, Groups E, F, G
Class III
Zone 20 and 21 Group IIIC

NEC/CEC:

Zone 21, AEx/Ex tb Group IIIC Db
Simultaneous Exposure
Marine Outside Type (Salt Water) for USA ONLY
Wet Locations
Type 3R, 4, 4X, IP66/67

ATEX/IECEX:

Zone 2 and 21
IP66
II 3G 2D
IK10
Ex ec IIC T5

AMLGL Dimensions in Millimeters (Inches)

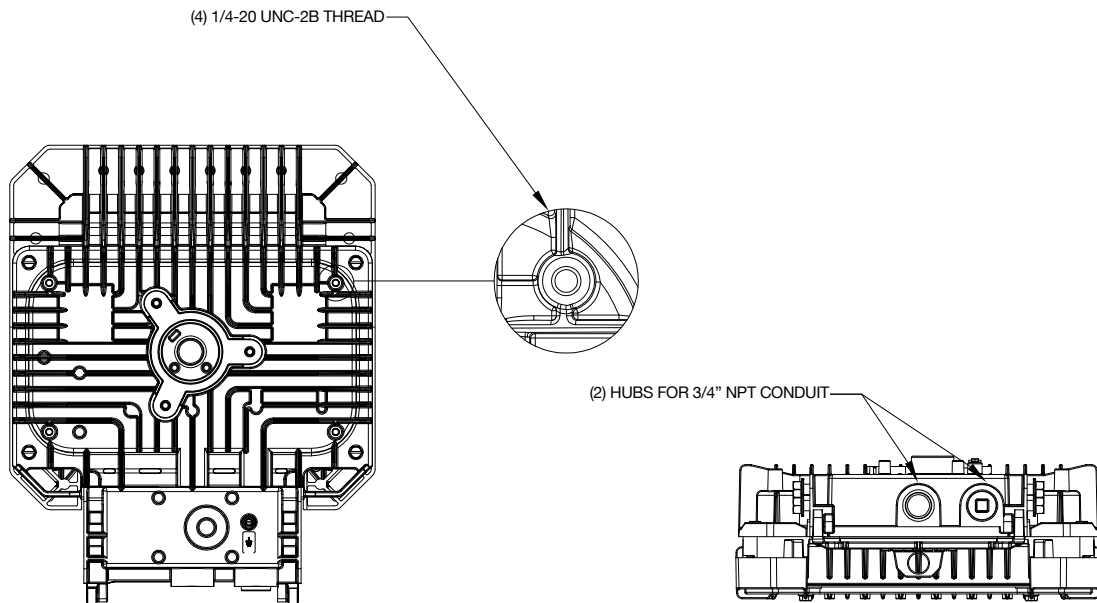
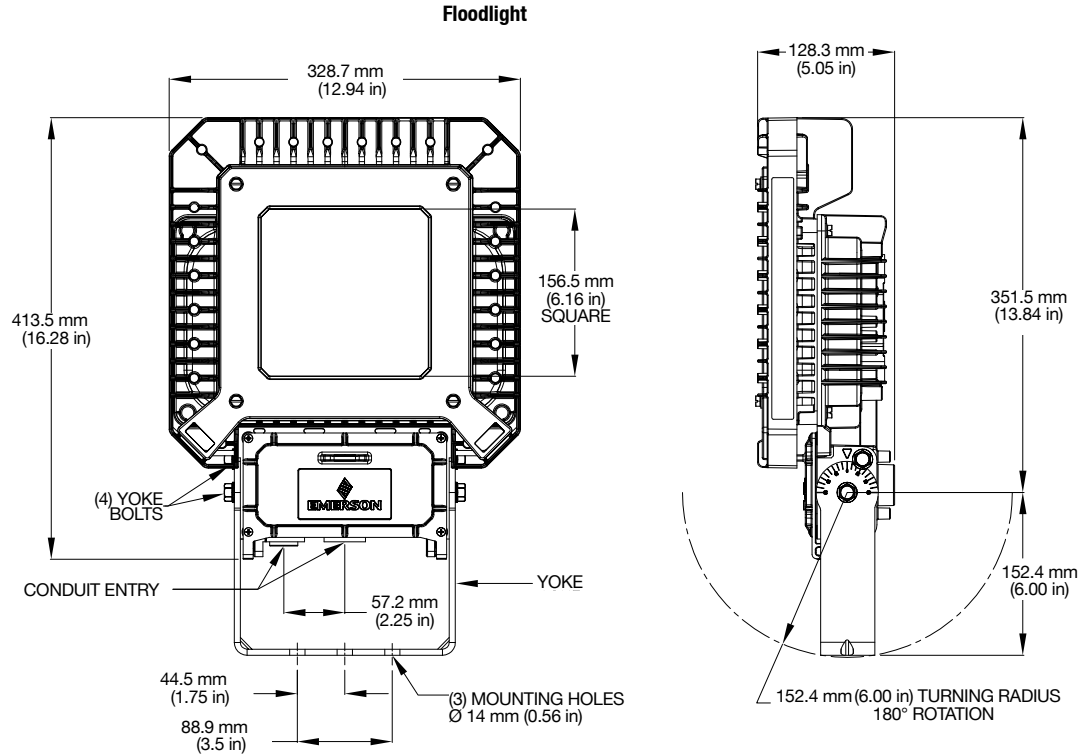

APPLETON™

LED/FLOODLIGHTS: NEC/CEC, ATEX/IECEX ENCLOSED AND GASKETED



Areamaster™ Generation 2 and High Lumen LED Luminaire Floodlight for Hazardous Locations

NEC/CEC:

Class I, Division 2, Groups A, B, C, D
Class I, Zone 2 AEx/Ex ec Group IIC Gc
Class II, Division 1 and 2, Groups E, F, G
Class III
Zone 20 and 21 Group IIIC

NEC/CEC:

Zone 21, AEx/Ex tb Group IIIC Db
Simultaneous Exposure
Marine Outside Type (Salt Water) for USA ONLY
Wet Locations
Type 3R, 4, 4X, IP66/67

ATEX/IECEX:

Zone 2 and 21
IP66
II 3G 2D
IK10
Ex ec IIC T5

AMLHL Dimensions in Millimeters (Inches)

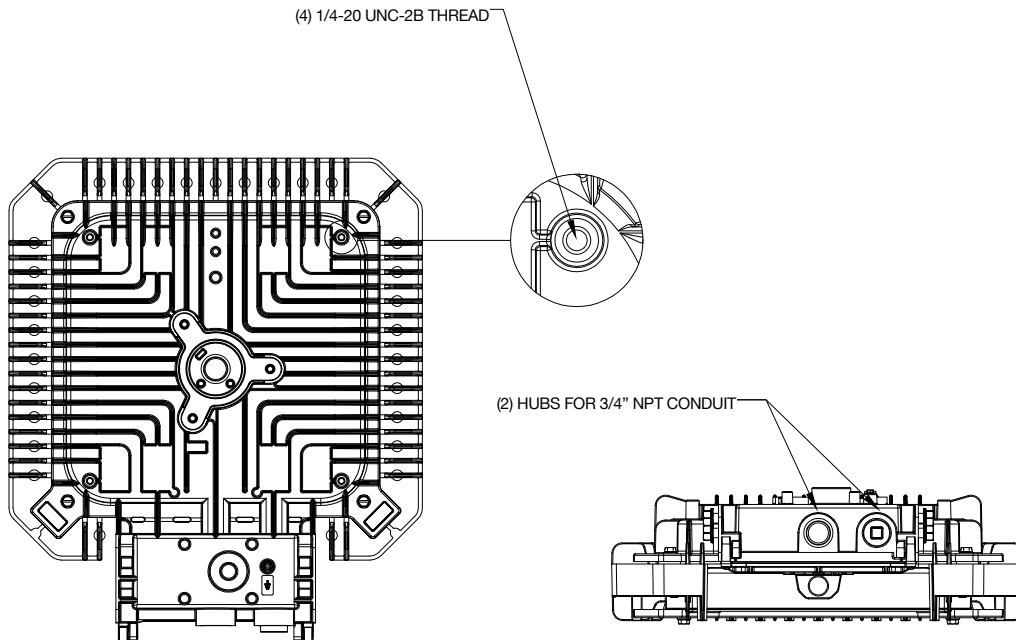
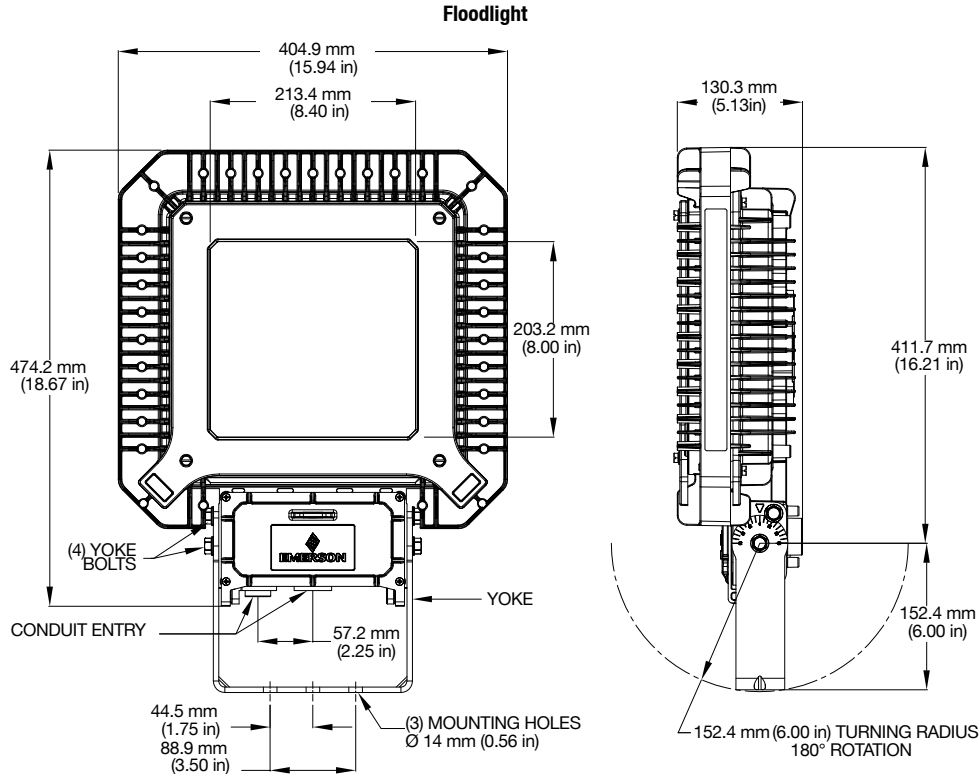

APPLETON™

LED/FLOODLIGHTS: NEC/CEC, ATEX/IECEX ENCLOSED AND GASKETED

Areamaster™ Generation 2 and High Lumen LED Luminaire Floodlight for Hazardous Locations

NEC/CEC:

Class I, Division 2, Groups A, B, C, D
Class I, Zone 2 AEx/Ex ec Group IIC Gc
Class II, Division 1 and 2, Groups E, F, G
Class III
Zone 20 and 21 Group IIIC

NEC/CEC:

Zone 21, AEx/Ex tb Group IIIC Db
Simultaneous Exposure
Marine Outside Type (Salt Water) for USA ONLY
Wet Locations
Type 3R, 4, 4X, IP66/67

ATEX/IECEX:

Zone 2 and 21
IP66
II 3G 2D
IK10
Ex ec IIC T5

Photometric Data – DATA SHOWN IS ABSOLUTE

NEMA 7x7, Frosted Glass, 5000K CCT

REPORT NUMBER: **AMLZL6CF6BUM**

Luminaire Lumens 7,454

POLAR CANDELA DISTRIBUTION

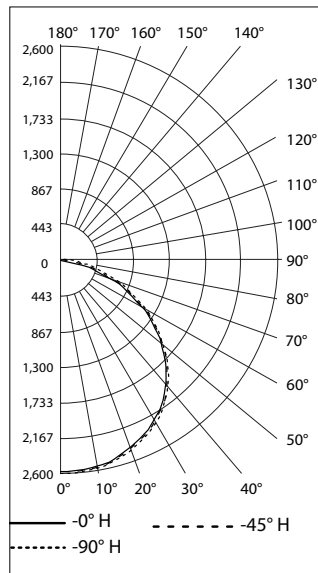

ISOFOOT CANDLE PLOT AT 45°

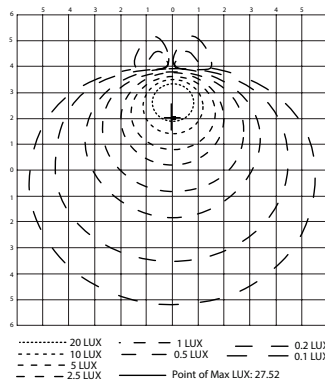

FLOOD SUMMARY

	Efficiency	Lumens	Horizontal Spread	Vertical Spread
Field (10%)	97.5%	7,280	159°	157°
Beam (50%)	75.5%	5,640	113°	114°
Total	100%	7,454		

Tilt Angle– 45 Degree LLF–0.9

Mounting Height (ft)	Forward Throw Distance			
	0.5fc/5lx m (ft)	1fc/11lx m (ft)	2fc/22lx m (ft)	5fc/54lx m (ft)
6 (20)	12 (40)	9 (30)	6 (20)	0
9 (30)	13 (42)	9 (29)	2 (8)	0
12 (40)	12 (40)	5 (16)	0	0

Mounting Height (ft)	Side-to-Side Distance			
	0.5fc/5lx m (ft)	1fc/11lx m (ft)	2fc/22lx m (ft)	5fc/54lx m (ft)
6 (20)	18 (60)	13 (44)	9 (30)	0
9 (30)	18 (60)	11 (36)	0	0
12 (40)	18 (60)	7 (24)	0	0

NEMA 7x7, Clear Glass, 5000K

REPORT NUMBER: **AMLZL6CG6BUM**

Luminaire Lumens 9,027

POLAR CANDELA DISTRIBUTION

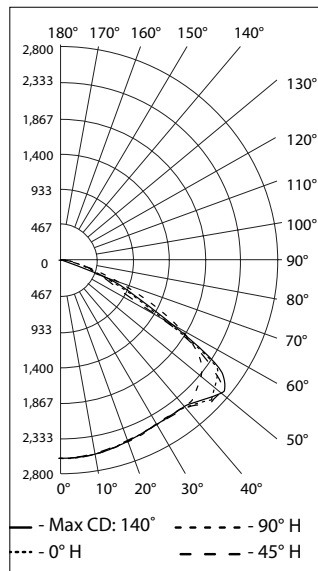

ISOFOOT CANDLE PLOT AT 45°

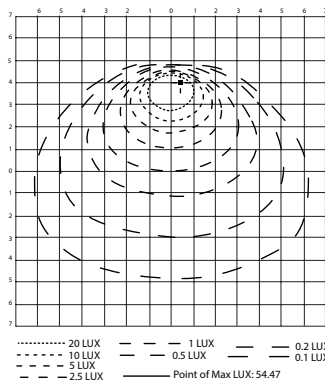

FLOOD SUMMARY

	Efficiency	Lumens	Horizontal Spread	Vertical Spread
Field (10%)	98.3%	8,897	134°	144°
Beam (50%)	90.1%	8,153	95°	120°
Total	100%	9,027		

Tilt Angle– 45 Degree LLF–0.9

Mounting Height (ft)	Forward Throw Distance			
	0.5fc/5lx m (ft)	1fc/11lx m (ft)	2fc/22lx m (ft)	5fc/54lx m (ft)
6 (20)	12 (40)	9 (30)	6 (20)	2 (5)
9 (30)	14 (45)	18 (60)	5 (15)	0
12 (40)	12 (40)	6 (20)	0	0

Mounting Height (ft)	Side-to-Side Distance			
	0.5fc/5lx m (ft)	1fc/11lx m (ft)	2fc/22lx m (ft)	5fc/54lx m (ft)
6 (20)	22 (72)	15 (50)	12 (40)	3 (10)
9 (30)	22 (72)	16 (54)	9 (30)	0
12 (40)	24 (80)	12 (40)	0	0



Areamaster™ Generation 2 and High Lumen LED Luminaire Floodlight for Hazardous Locations

NEC/CEC:

Class I, Division 2, Groups A, B, C, D
Class I, Zone 2 AEx/Ex ec Group IIC Gc
Class II, Division 1 and 2, Groups E, F, G
Class III
Zone 20 and 21 Group IIIC

NEC/CEC:

Zone 21, AEx/Ex tb Group IIIC Db
Simultaneous Exposure
Marine Outside Type (Salt Water) for USA ONLY
Wet Locations
Type 3R, 4, 4X, IP66/67

ATEX/IECEX:

Zone 2 and 21
IP66
II 3G 2D
IK10
Ex ec IIC T5

Photometric Data – DATA SHOWN IS ABSOLUTE

NEMA 7x6, Clear Glass, 5000K CCT

REPORT NUMBER: **AMLZL6CG7BUM**

Luminaire Lumens 9,196

POLAR CANDELA DISTRIBUTION

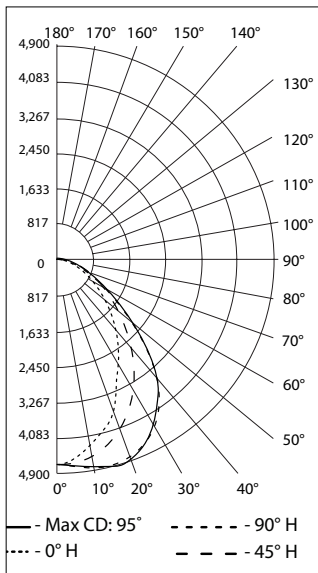

ISOFOOT CANDLE PLOT AT 45°

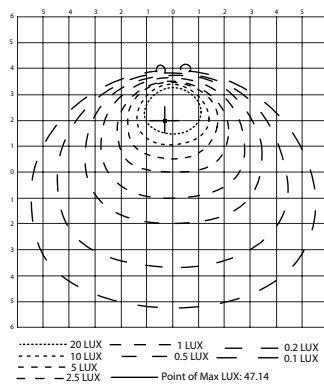

FLOOD SUMMARY

	Efficiency	Lumens	Horizontal Spread	Vertical Spread
Field (10%)	96%	8,843	139°	128°
Beam (50%)	65.1%	6,000	95°	69°
Total	100%	9,196		

Tilt Angle– 45 Degree LLF–0.9

↓
Forward Throw Distance

Mounting Height (ft)	0.5fc/5lx m (ft)	1fc/11lx m (ft)	2fc/22lx m (ft)	5fc/54lx m (ft)
6 (20)	13 (44)	10 (34)	9 (28)	4 (12)
9 (30)	16 (53)	13 (42)	8 (26)	0
12 (40)	16 (52)	12 (40)	0	0

← →
Side-to-Side Distance

Mounting Height (ft)	0.5fc/5lx m (ft)	1fc/11lx m (ft)	2fc/22lx m (ft)	5fc/54lx m (ft)
6 (20)	21 (68)	16 (52)	12 (40)	4 (14)
9 (30)	22 (72)	17 (57)	9 (30)	0
12 (40)	24 (80)	15 (48)	0	0

NEMA 7x7, Frosted Glass, 5000K CCT

REPORT NUMBER: **AMLZL7CF6BUM**

Luminaire Lumens 11,563

POLAR CANDELA DISTRIBUTION

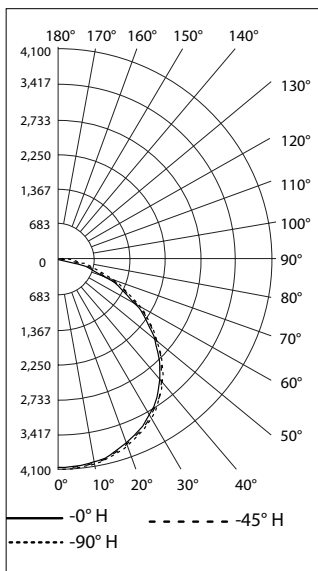

ISOFOOT CANDLE PLOT AT 45°

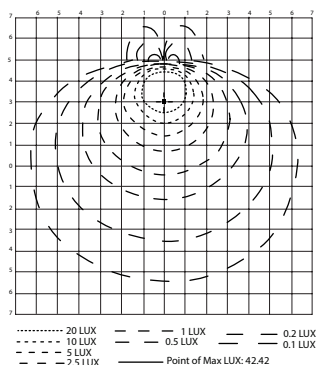

FLOOD SUMMARY

	Efficiency	Lumens	Horizontal Spread	Vertical Spread
Field (10%)	97.5%	11,295	159°	156°
Beam (50%)	75.3%	8,725	112°	114°
Total	100%	11,563		

Tilt Angle– 45 Degree LLF–0.9

↓
Forward Throw Distance

Mounting Height (ft)	0.5fc/5lx m (ft)	1fc/11lx m (ft)	2fc/22lx m (ft)	5fc/54lx m (ft)
6 (20)	15 (48)	11 (36)	8 (26)	3 (10)
9 (30)	16 (51)	9 (30)	5 (15)	0
12 (40)	15 (50)	10 (32)	0	0

← →
Side-to-Side Distance

Mounting Height (ft)	0.5fc/5lx m (ft)	1fc/11lx m (ft)	2fc/22lx m (ft)	5fc/54lx m (ft)
6 (20)	22 (72)	15 (50)	12 (40)	5 (16)
9 (30)	22 (72)	16 (54)	9 (30)	0
12 (40)	24 (80)	17 (56)	0	0

Areamaster™ Generation 2 and High Lumen LED Luminaire Floodlight for Hazardous Locations

NEC/CEC:

Class I, Division 2, Groups A, B, C, D
Class I, Zone 2 AEx/Ex ec Group IIC Gc
Class II, Division 1 and 2, Groups E, F, G
Class III
Zone 20 and 21 Group IIIC

NEC/CEC:

Zone 21, AEx/Ex tb Group IIIC Db
Simultaneous Exposure
Marine Outside Type (Salt Water) for USA ONLY
Wet Locations
Type 3R, 4, 4X, IP66/67

ATEX/IECEX:

Zone 2 and 21
IP66
II 3G 2D
IK10
Ex ec IIC T5

Photometric Data – DATA SHOWN IS ABSOLUTE

NEMA 7x7, Clear Glass, 5000K

REPORT NUMBER: AMLZL7CG6BUM

Luminaire Lumens 14,029

POLAR CANDELA DISTRIBUTION

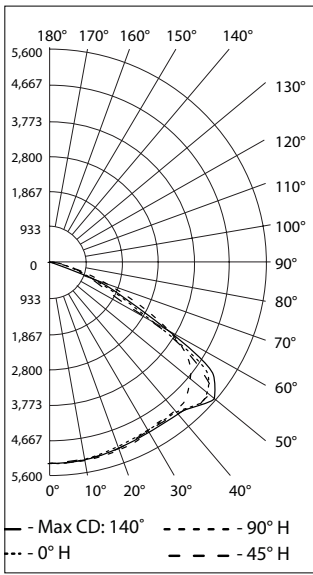

ISOFOOT CANDLE PLOT AT 45°

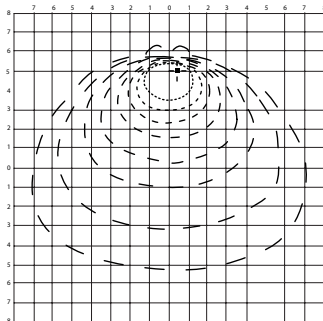

FLOOD SUMMARY

	Efficiency	Lumens	Horizontal Spread	Vertical Spread
Field (10%)	98.4%	13,830	133°	145°
Beam (50%)	90.1%	12,669	94°	121°
Total	100%	14,029		

Tilt Angle– 45 Degree LLF–0.9

Mounting Height (ft)	Forward Throw Distance			
	0.5fc/5lx m (ft)	1fc/11lx m (ft)	2fc/22lx m (ft)	5fc/54lx m (ft)
6 (20)	14 (46)	11 (36)	8 (25)	4 (12)
9 (30)	16 (53)	11 (36)	7 (23)	0
12 (40)	16 (52)	10 (34)	2 (8)	0

Mounting Height (ft)	Side-to-Side Distance			
	0.5fc/5lx m (ft)	1fc/11lx m (ft)	2fc/22lx m (ft)	5fc/54lx m (ft)
6 (20)	24 (80)	18 (60)	13 (44)	9 (28)
9 (30)	27 (90)	20 (66)	15 (48)	0
12 (40)	28 (92)	21 (68)	0	0

NEMA 7x6, Clear Glass, 5000K CCT

REPORT NUMBER: AMLZL7CG7BUM

Luminaire Lumens 14,343

POLAR CANDELA DISTRIBUTION

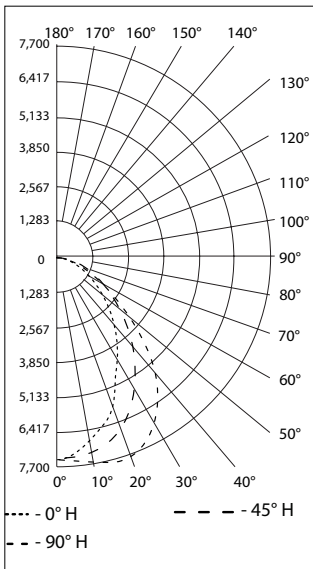

ISOFOOT CANDLE PLOT AT 45°

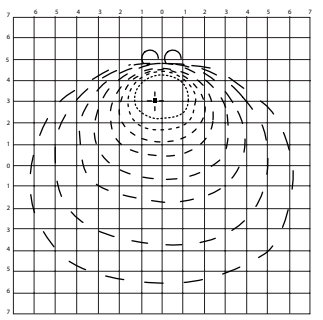

FLOOD SUMMARY

	Efficiency	Lumens	Horizontal Spread	Vertical Spread
Field (10%)	96%	13,801	138°	127°
Beam (50%)	65.3%	9,390	94°	69°
Total	100%	14,343		

Tilt Angle– 45 Degree LLF–0.9

Mounting Height (ft)	Forward Throw Distance			
	0.5fc/5lx m (ft)	1fc/11lx m (ft)	2fc/22lx m (ft)	5fc/54lx m (ft)
6 (20)	16 (52)	13 (42)	9 (30)	7 (22)
9 (30)	18 (60)	14 (45)	10 (33)	0
12 (40)	20 (64)	15 (48)	6 (20)	0

Mounting Height (ft)	Side-to-Side Distance			
	0.5fc/5lx m (ft)	1fc/11lx m (ft)	2fc/22lx m (ft)	5fc/54lx m (ft)
6 (20)	23 (76)	18 (60)	13 (44)	9 (30)
9 (30)	27 (90)	20 (66)	15 (48)	0
12 (40)	29 (60)	22 (72)	9 (28)	0

APPLETON™

LED/FLOODLIGHTS: NEC/CEC, ATEX/IECEX ENCLOSED AND GASKETED



Areamaster™ Generation 2 and High Lumen LED Luminaire Floodlight for Hazardous Locations

NEC/CEC:

Class I, Division 2, Groups A, B, C, D
Class I, Zone 2 AEx/Ex ec Group IIC Gc
Class II, Division 1 and 2, Groups E, F, G
Class III
Zone 20 and 21 Group IIIC

NEC/CEC:

Zone 21, AEx/Ex tb Group IIIC Db
Simultaneous Exposure
Marine Outside Type (Salt Water) for USA ONLY
Wet Locations
Type 3R, 4, 4X, IP66/67

ATEX/IECEX:

Zone 2 and 21
IP66
II 3G 2D
IK10
Ex ec IIC T5

Photometric Data — DATA SHOWN IS ABSOLUTE

NEMA 7x7, Frosted Glass, 5000K CCT

REPORT NUMBER: **AMLZL8CF6BUM**

Luminaire Lumens 14,993

POLAR CANDELA DISTRIBUTION

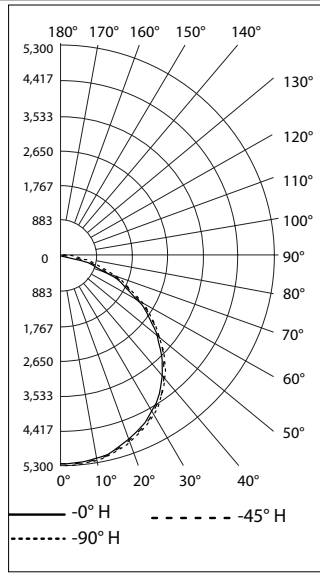

ISOFOOT CANDLE PLOT AT 45°

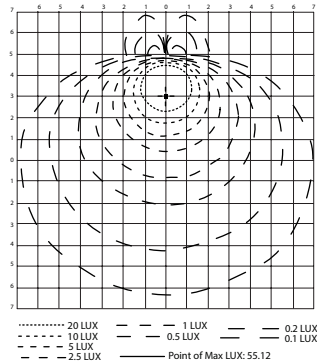

FLOOD SUMMARY

	Efficiency	Lumens	Horizontal Spread	Vertical Spread
Field (10%)	97.5%	14,648	159°	156°
Beam (50%)	75.4%	11,323	112°	114°
Total	100%	14,993		

Tilt Angle— 45 Degree LLF—0.9

Mounting Height (ft)	Forward Throw Distance			
	0.5fc/5lx m (ft)	1fc/11lx m (ft)	2fc/22lx m (ft)	5fc/54lx m (ft)
6 (20)	16 (52)	12 (40)	9 (30)	6 (20)
9 (30)	18 (59)	14 (54)	9 (30)	0
12 (40)	17 (56)	12 (40)	0	0

Side-to-Side Distance

Mounting Height (ft)	Side-to-Side Distance			
	0.5fc/5lx m (ft)	1fc/11lx m (ft)	2fc/22lx m (ft)	5fc/54lx m (ft)
6 (20)	23 (76)	18 (60)	13 (44)	6 (20)
9 (30)	26 (84)	18 (60)	14 (45)	0
12 (40)	27 (88)	20 (64)	7 (24)	0

NEMA 7x7, Clear Glass, 5000K CCT

REPORT NUMBER: **AMLZL8CG6BUM**

Luminaire Lumens 18,104

POLAR CANDELA DISTRIBUTION

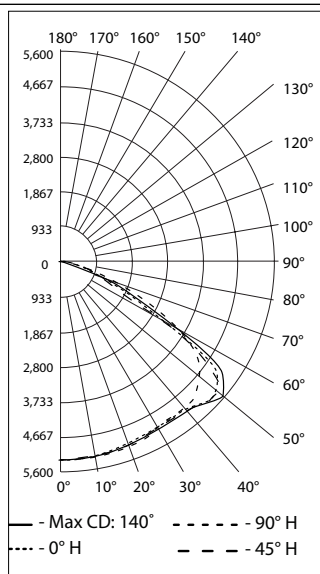

ISOFOOT CANDLE PLOT AT 45°

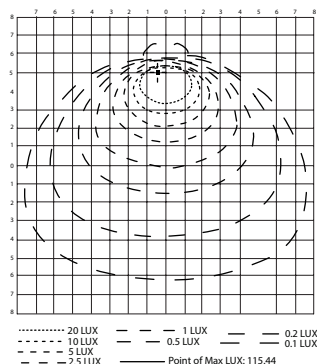

FLOOD SUMMARY

	Efficiency	Lumens	Horizontal Spread	Vertical Spread
Field (10%)	98.3%	17,835	132°	145°
Beam (50%)	90%	16,330	93°	121°
Total	100%	18,104		

Tilt Angle— 45 Degree LLF—0.9

Mounting Height (ft)	Forward Throw Distance			
	0.5fc/5lx m (ft)	1fc/11lx m (ft)	2fc/22lx m (ft)	5fc/54lx m (ft)
6 (20)	16 (52)	12 (40)	9 (30)	5 (18)
9 (30)	9 (30)	13 (42)	9 (30)	0
12 (40)	18 (60)	12 (40)	0	0

Side-to-Side Distance

Mounting Height (ft)	Side-to-Side Distance			
	0.5fc/5lx m (ft)	1fc/11lx m (ft)	2fc/22lx m (ft)	5fc/54lx m (ft)
6 (20)	27 (88)	22 (72)	15 (50)	10 (32)
9 (30)	31 (102)	22 (72)	16 (54)	2 (6)
12 (40)	32 (104)	24 (80)	12 (40)	0

Areamaster™ Generation 2 and High Lumen LED Luminaire Floodlight for Hazardous Locations

NEC/CEC:

Class I, Division 2, Groups A, B, C, D
Class I, Zone 2 AEx/Ex ec Group IIC Gc
Class II, Division 1 and 2, Groups E, F, G
Class III
Zone 20 and 21 Group IIIC

NEC/CEC:

Zone 21, AEx/Ex tb Group IIIC Db
Simultaneous Exposure
Marine Outside Type (Salt Water) for USA ONLY
Wet Locations
Type 3R, 4, 4X, IP66/67

ATEX/IECEX:

Zone 2 and 21
IP66
II 3G 2D
IK10
Ex ec IIC T5

Photometric Data — DATA SHOWN IS ABSOLUTE

NEMA 7x6, Clear Glass, 5000K

REPORT NUMBER: AMLZL8CG7BUM

Luminaire Lumens 18,558

POLAR CANDELA DISTRIBUTION

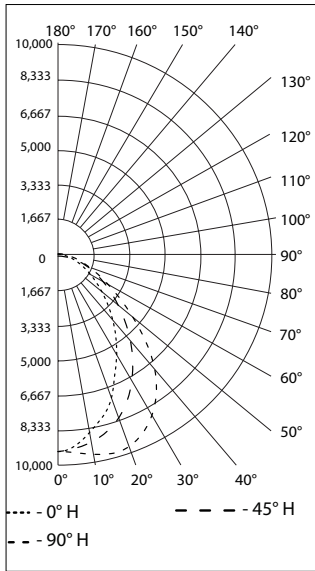

ISOFOOT CANDLE PLOT AT 45°

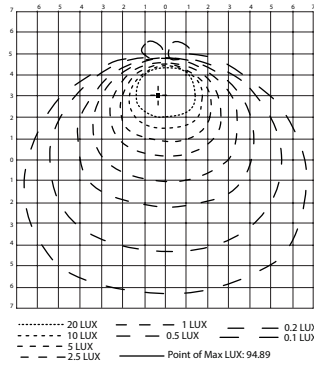

FLOOD SUMMARY

	Efficiency	Lumens	Horizontal Spread	Vertical Spread
Field (10%)	96%	17,846	138°	127°
Beam (50%)	65.1%	12,103	94°	69°
Total	100%	18,558		

Tilt Angle— 45 Degree LLF—0.9

Mounting Height (ft)	Forward Throw Distance			
	0.5fc/5lx m (ft)	1fc/11lx m (ft)	2fc/22lx m (ft)	5fc/54lx m (ft)
6 (20)	17 (56)	13 (44)	11 (36)	7 (24)
9 (30)	19 (63)	16 (53)	12 (41)	4 (12)
12 (40)	20 (66)	18 (60)	12 (40)	0

Mounting Height (ft)	Side-to-Side Distance			
	0.5fc/5lx m (ft)	1fc/11lx m (ft)	2fc/22lx m (ft)	5fc/54lx m (ft)
6 (20)	24 (80)	18 (60)	16 (52)	11 (36)
9 (30)	29 (96)	23 (75)	18 (60)	4 (12)
12 (40)	32 (104)	24 (80)	12 (40)	0

APPLETON™

LED/FLOODLIGHTS: NEC/CEC, ATEX/IECEX ENCLOSED AND GASKETED



Areamaster™ Generation 2 and High Lumen LED Luminaire Floodlight for Hazardous Locations

NEC/CEC:
Class I, Division 2, Groups A, B, C, D
Class I, Zone 2 AEx/Ex ec Group IIC Gc
Class II, Division 1 and 2, Groups E, F, G
Class III
Zone 20 and 21 Group IIIC

NEC/CEC:
Zone 21, AEx/Ex tb Group IIIC Db
Simultaneous Exposure
Marine Outside Type (Salt Water) for USA ONLY
Wet Locations
Type 3R, 4, 4X, IP66/67

ATEX/IECEX:
Zone 2 and 21
IP66
II 3G 2D
IK10
Ex ec IIC T5

Photometric Data – DATA SHOWN IS ABSOLUTE

NEMA 7x7, Frosted Glass, 5000K CCT
REPORT NUMBER: **AMLZL6CF6BUM**
Luminaire Lumens 7,454

POLAR CANDELA DISTRIBUTION

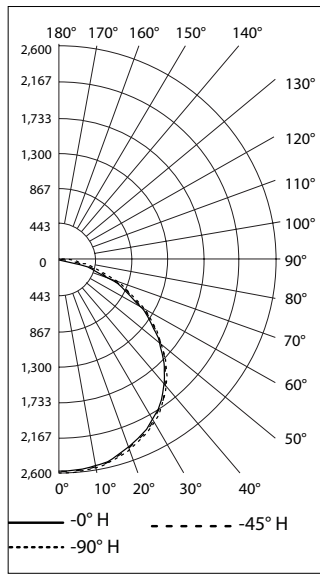

ISOFOOT CANDLE PLOT AT 45°

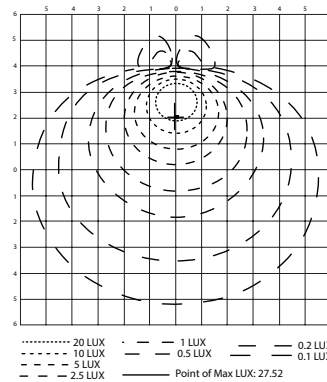

FLOOD SUMMARY

	Efficiency	Lumens	Horizontal Spread	Vertical Spread
Field (10%)	97.5%	7,280	159°	157°
Beam (50%)	75.5%	5,640	113°	114°
Total	100%	7,454		

Tilt Angle– 45 Degree LLF–0.9

Mounting Height (ft)	Forward Throw Distance			
	0.5fc/5lx m (ft)	1fc/11lx m (ft)	2fc/22lx m (ft)	5fc/54lx m (ft)
6 (20)	12 (40)	9 (30)	6 (20)	0
9 (30)	13 (42)	9 (29)	2 (8)	0
12 (40)	12 (40)	5 (16)	0	0

Side-to-Side Distance

Mounting Height (ft)	Side-to-Side Distance			
	0.5fc/5lx m (ft)	1fc/11lx m (ft)	2fc/22lx m (ft)	5fc/54lx m (ft)
6 (20)	18 (60)	13 (44)	9 (30)	0
9 (30)	18 (60)	11 (36)	0	0
12 (40)	18 (60)	7 (24)	0	0

NEMA 7x7, Clear Glass, 5000K

REPORT NUMBER: **AMLZL6CG6BUM**
Luminaire Lumens 9,027

POLAR CANDELA DISTRIBUTION

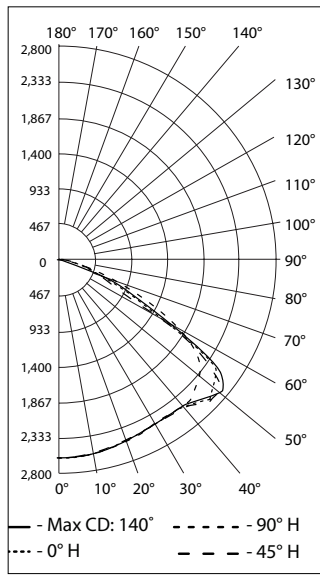

ISOFOOT CANDLE PLOT AT 45°

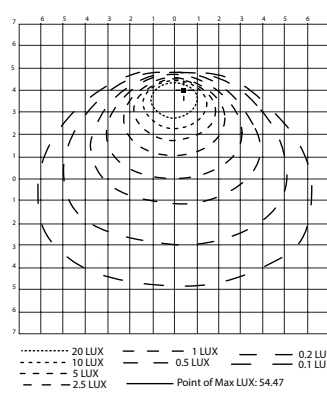

FLOOD SUMMARY

	Efficiency	Lumens	Horizontal Spread	Vertical Spread
Field (10%)	98.3%	8,897	134°	144°
Beam (50%)	90.1%	8,153	95°	120°
Total	100%	9,027		

Tilt Angle– 45 Degree LLF–0.9

Mounting Height (ft)	Forward Throw Distance			
	0.5fc/5lx m (ft)	1fc/11lx m (ft)	2fc/22lx m (ft)	5fc/54lx m (ft)
6 (20)	12 (40)	9 (30)	6 (20)	2 (5)
9 (30)	14 (45)	18 (60)	5 (15)	0
12 (40)	12 (40)	6 (20)	0	0

Side-to-Side Distance

Mounting Height (ft)	Side-to-Side Distance			
	0.5fc/5lx m (ft)	1fc/11lx m (ft)	2fc/22lx m (ft)	5fc/54lx m (ft)
6 (20)	22 (72)	15 (50)	12 (40)	3 (10)
9 (30)	22 (72)	16 (54)	9 (30)	0
12 (40)	24 (80)	12 (40)	0	0

APPLETON™

LED/FLOODLIGHTS: NEC/CEC, ATEX/IECEX ENCLOSED AND GASKETED

Areamaster™ Generation 2 and High Lumen LED Luminaire Floodlight for Hazardous Locations

NEC/CEC:

Class I, Division 2, Groups A, B, C, D
Class I, Zone 2 AEx/Ex ec Group IIC Gc
Class II, Division 1 and 2, Groups E, F, G
Class III
Zone 20 and 21 Group IIIC

NEC/CEC:

Zone 21, AEx/Ex tb Group IIIC Db
Simultaneous Exposure
Marine Outside Type (Salt Water) for USA ONLY
Wet Locations
Type 3R, 4, 4X, IP66/67

ATEX/IECEX:

Zone 2 and 21
IP66
II 3G 2D
IK10
Ex ec IIC T5

Photometric Data – DATA SHOWN IS ABSOLUTE

NEMA 7x6, Clear Glass, 5000K CCT

REPORT NUMBER: AMLZL6CG7BUM

Luminaire Lumens 9,196

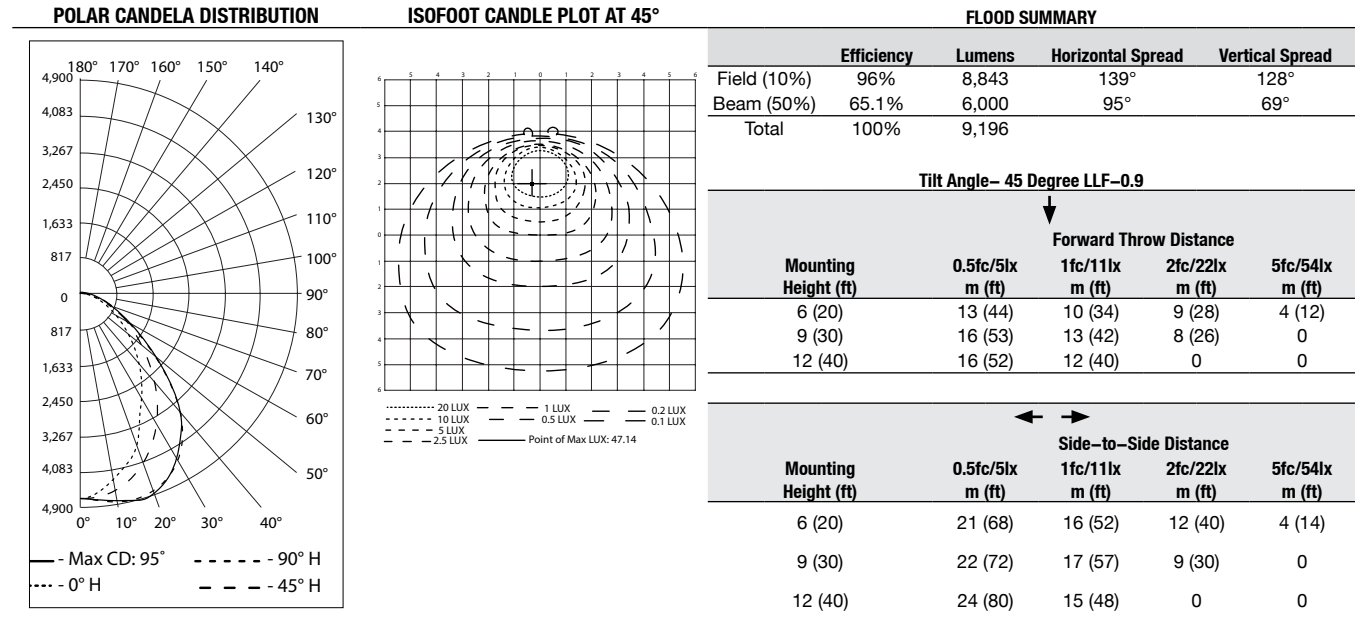

NEMA 7x7, Frosted Glass, 5000K CCT

REPORT NUMBER: AMLZL7CF6BUM

Luminaire Lumens 11,563

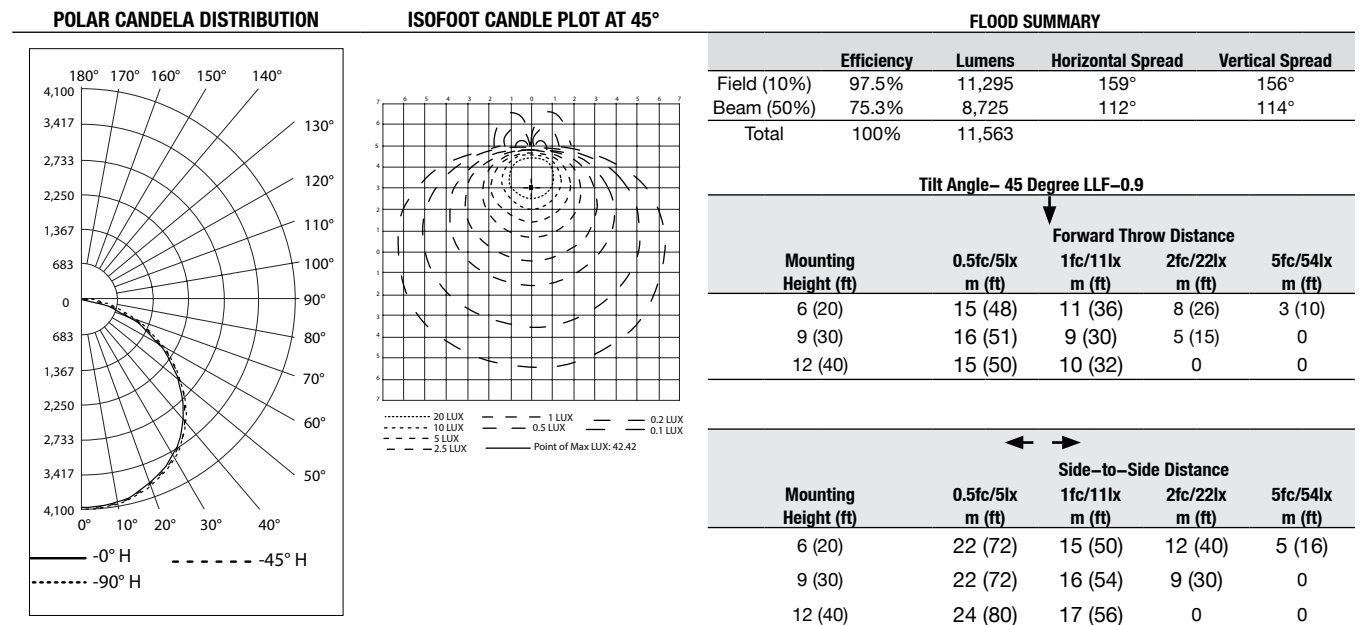

APPLETON™

LED/FLOODLIGHTS: NEC/CEC, ATEX/IECEX ENCLOSED AND GASKETED



Areamaster™ Generation 2 and High Lumen LED Luminaire Floodlight for Hazardous Locations

NEC/CEC:

Class I, Division 2, Groups A, B, C, D
Class I, Zone 2 AEx/Ex ec Group IIC Gc
Class II, Division 1 and 2, Groups E, F, G
Class III
Zone 20 and 21 Group IIIC

NEC/CEC:

Zone 21, AEx/Ex tb Group IIIC Db
Simultaneous Exposure
Marine Outside Type (Salt Water) for USA ONLY
Wet Locations
Type 3R, 4, 4X, IP66/67

ATEX/IECEX:

Zone 2 and 21
IP66
II 3G 2D
IK10
Ex ec IIC T5

Photometric Data – DATA SHOWN IS ABSOLUTE

NEMA 7x7, Clear Glass, 5000K

REPORT NUMBER: AMLZL7CG6BUM

Luminaire Lumens 14,029

POLAR CANDELA DISTRIBUTION

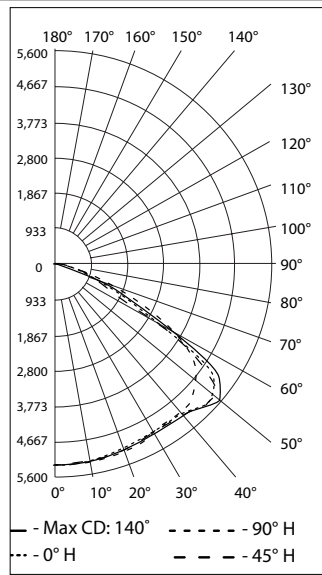

ISOFOOT CANDLE PLOT AT 45°

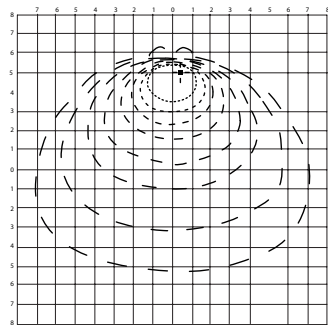

----- 20 LUX - - - - 1 LUX - - - - 0.2 LUX
- - - - 10 LUX - - - - 0.5 LUX - - - - 0.1 LUX
- - - - 5 LUX - - - - 2.5 LUX

FLOOD SUMMARY

	Efficiency	Lumens	Horizontal Spread	Vertical Spread
Field (10%)	98.4%	13,830	133°	145°
Beam (50%)	90.1%	12,669	94°	121°
Total	100%	14,029		

Tilt Angle– 45 Degree LLF–0.9

Mounting Height (ft)	Forward Throw Distance			
	0.5fc/5lx m (ft)	1fc/11lx m (ft)	2fc/22lx m (ft)	5fc/54lx m (ft)
6 (20)	14 (46)	11 (36)	8 (25)	4 (12)
9 (30)	16 (53)	11 (36)	7 (23)	0
12 (40)	16 (52)	10 (34)	2 (8)	0

Side-to-Side Distance

Mounting Height (ft)	Side-to-Side Distance			
	0.5fc/5lx m (ft)	1fc/11lx m (ft)	2fc/22lx m (ft)	5fc/54lx m (ft)
6 (20)	24 (80)	18 (60)	13 (44)	9 (28)
9 (30)	27 (90)	20 (66)	15 (48)	0
12 (40)	28 (92)	21 (68)	0	0

NEMA 7x6, Clear Glass, 5000K CCT

REPORT NUMBER: AMLZL7CG7BUM

Luminaire Lumens 14,343

POLAR CANDELA DISTRIBUTION

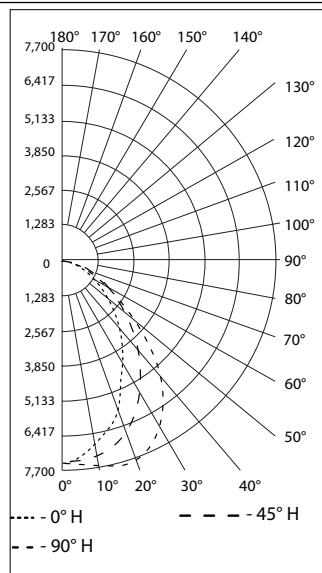

ISOFOOT CANDLE PLOT AT 45°

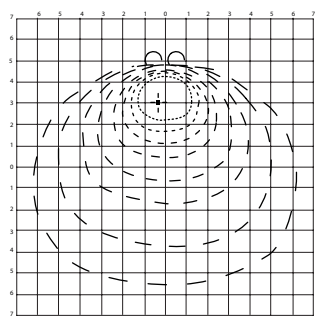

----- 20 LUX - - - - 1 LUX - - - - 0.2 LUX
- - - - 10 LUX - - - - 0.5 LUX - - - - 0.1 LUX
- - - - 5 LUX - - - - 2.5 LUX

FLOOD SUMMARY

	Efficiency	Lumens	Horizontal Spread	Vertical Spread
Field (10%)	96%	13,801	138°	127°
Beam (50%)	65.3%	9,390	94°	69°
Total	100%	14,343		

Tilt Angle– 45 Degree LLF–0.9

Mounting Height (ft)	Forward Throw Distance			
	0.5fc/5lx m (ft)	1fc/11lx m (ft)	2fc/22lx m (ft)	5fc/54lx m (ft)
6 (20)	16 (52)	13 (42)	9 (30)	7 (22)
9 (30)	18 (60)	14 (45)	10 (33)	0
12 (40)	20 (64)	15 (48)	6 (20)	0

Side-to-Side Distance

Mounting Height (ft)	Side-to-Side Distance			
	0.5fc/5lx m (ft)	1fc/11lx m (ft)	2fc/22lx m (ft)	5fc/54lx m (ft)
6 (20)	23 (76)	18 (60)	13 (44)	9 (30)
9 (30)	27 (90)	20 (66)	15 (48)	0
12 (40)	29 (60)	22 (72)	9 (28)	0

APPLETON™

LED/FLOODLIGHTS: NEC/CEC, ATEX/IECEX ENCLOSED AND GASKETED

Areamaster™ Generation 2 and High Lumen LED Luminaire Floodlight for Hazardous Locations

NEC/CEC:

Class I, Division 2, Groups A, B, C, D
Class I, Zone 2 AEx/Ex ec Group IIC Gc
Class II, Division 1 and 2, Groups E, F, G
Class III
Zone 20 and 21 Group IIIC

NEC/CEC:

Zone 21, AEx/Ex tb Group IIIC Db
Simultaneous Exposure
Marine Outside Type (Salt Water) for USA ONLY
Wet Locations
Type 3R, 4, 4X, IP66/67

ATEX/IECEX:

Zone 2 and 21
IP66
II 3G 2D
IK10
Ex ec IIC T5

Photometric Data – DATA SHOWN IS ABSOLUTE

NEMA 7x7, Frosted Glass, 5000K CCT

REPORT NUMBER: AMLZL8CF6BUM

Luminaire Lumens 14,993

POLAR CANDELA DISTRIBUTION

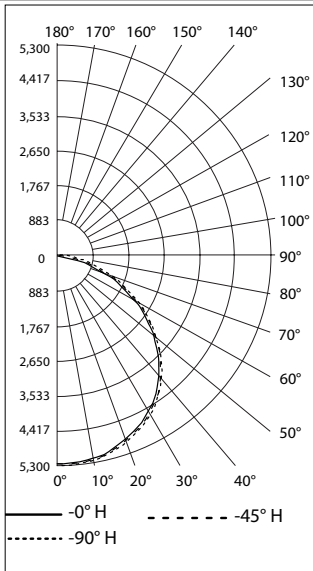

ISOFOOT CANDLE PLOT AT 45°

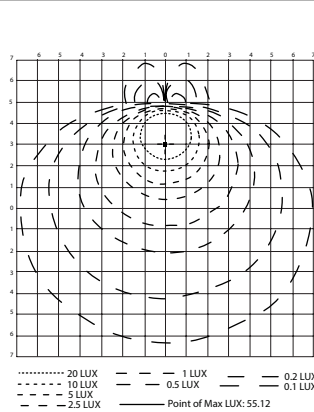

FLOOD SUMMARY

	Efficiency	Lumens	Horizontal Spread	Vertical Spread
Field (10%)	97.5%	14,648	159°	156°
Beam (50%)	75.4%	11,323	112°	114°
Total	100%	14,993		

Tilt Angle– 45 Degree LLF–0.9

Mounting Height (ft)	Forward Throw Distance			
	0.5fc/5lx m (ft)	1fc/11lx m (ft)	2fc/22lx m (ft)	5fc/54lx m (ft)
6 (20)	16 (52)	12 (40)	9 (30)	6 (20)
9 (30)	18 (59)	14 (54)	9 (30)	0
12 (40)	17 (56)	12 (40)	0	0

Mounting Height (ft)	Side-to-Side Distance			
	0.5fc/5lx m (ft)	1fc/11lx m (ft)	2fc/22lx m (ft)	5fc/54lx m (ft)
6 (20)	23 (76)	18 (60)	13 (44)	6 (20)
9 (30)	26 (84)	18 (60)	14 (45)	0
12 (40)	27 (88)	20 (64)	7 (24)	0

NEMA 7x7, Clear Glass, 5000K CCT

REPORT NUMBER: AMLZL8CG6BUM

Luminaire Lumens 18,104

POLAR CANDELA DISTRIBUTION

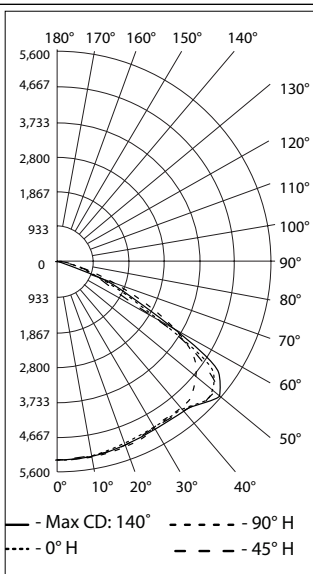

ISOFOOT CANDLE PLOT AT 45°

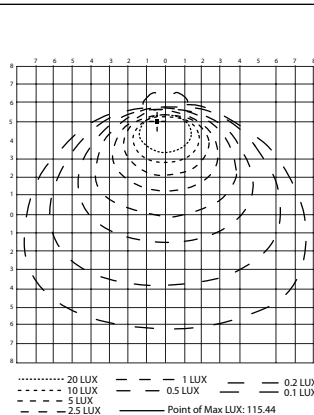

FLOOD SUMMARY

	Efficiency	Lumens	Horizontal Spread	Vertical Spread
Field (10%)	98.3%	17,835	132°	145°
Beam (50%)	90%	16,330	93°	121°
Total	100%	18,104		

Tilt Angle– 45 Degree LLF–0.9

Mounting Height (ft)	Forward Throw Distance			
	0.5fc/5lx m (ft)	1fc/11lx m (ft)	2fc/22lx m (ft)	5fc/54lx m (ft)
6 (20)	16 (52)	12 (40)	9 (30)	5 (18)
9 (30)	9 (30)	13 (42)	9 (30)	0
12 (40)	18 (60)	12 (40)	0	0

Mounting Height (ft)	Side-to-Side Distance			
	0.5fc/5lx m (ft)	1fc/11lx m (ft)	2fc/22lx m (ft)	5fc/54lx m (ft)
6 (20)	27 (88)	22 (72)	15 (50)	10 (32)
9 (30)	31 (102)	22 (72)	16 (54)	2 (6)
12 (40)	32 (104)	24 (80)	12 (40)	0

APPLETON™

LED/FLOODLIGHTS: NEC/CEC, ATEX/IECEX ENCLOSED AND GASKETED



Areamaster™ Generation 2 and High Lumen LED Luminaire Floodlight for Hazardous Locations

NEC/CEC:

Class I, Division 2, Groups A, B, C, D
Class I, Zone 2 AEx/Ex ec Group IIC Gc
Class II, Division 1 and 2, Groups E, F, G
Class III
Zone 20 and 21 Group IIIC

NEC/CEC:

Zone 21, AEx/Ex tb Group IIIC Db
Simultaneous Exposure
Marine Outside Type (Salt Water) for USA ONLY
Wet Locations
Type 3R, 4, 4X, IP66/67

ATEX/IECEX:

Zone 2 and 21
IP66
II 3G 2D
IK10
Ex ec IIC T5

Photometric Data – DATA SHOWN IS ABSOLUTE

NEMA 7x6, Clear Glass, 5000K

REPORT NUMBER: AMLZL8CG7BUM

Luminaire Lumens 18,558

POLAR CANDELA DISTRIBUTION

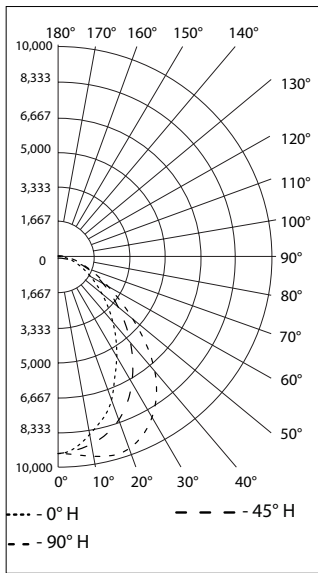

ISOFOOT CANDLE PLOT AT 45°

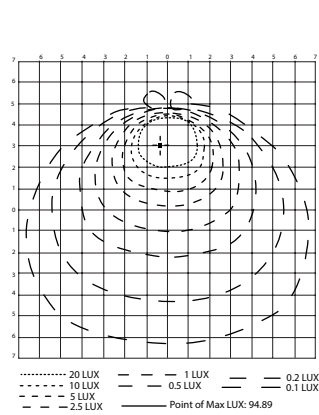

FLOOD SUMMARY

	Efficiency	Lumens	Horizontal Spread	Vertical Spread
Field (10%)	96%	17,846	138°	127°
Beam (50%)	65.1%	12,103	94°	69°
Total	100%	18,558		

Tilt Angle– 45 Degree LLF–0.9

Mounting Height (ft)	Forward Throw Distance			
	0.5fc/5lx m (ft)	1fc/11lx m (ft)	2fc/22lx m (ft)	5fc/54lx m (ft)
6 (20)	17 (56)	13 (44)	11 (36)	7 (24)
9 (30)	19 (63)	16 (53)	12 (41)	4 (12)
12 (40)	20 (66)	18 (60)	12 (40)	0

Mounting Height (ft)	Side-to-Side Distance			
	0.5fc/5lx m (ft)	1fc/11lx m (ft)	2fc/22lx m (ft)	5fc/54lx m (ft)
6 (20)	24 (80)	18 (60)	16 (52)	11 (36)
9 (30)	29 (96)	23 (75)	18 (60)	4 (12)
12 (40)	32 (104)	24 (80)	12 (40)	0

APPLETON™

LED/FLOODLIGHTS: NEC/CEC, ATEX/IECEX ENCLOSED AND GASKETED